

**Analog - Digital - Converter**

# **AWA/2X12B**

**2 x 12 Bit**

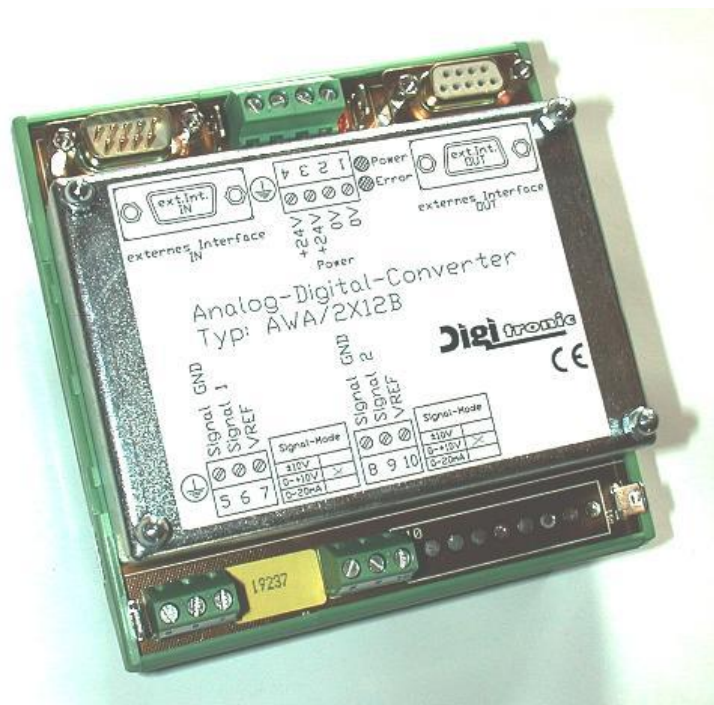

## **Digitronic Automationsanlagen GmbH**

Steinbeisstraße 3 · D - 72636 Frickenhausen · Tel. (+49)7022/40590-0 · Fax -10  
Auf der Langwies 1 · D - 65510 Hünstetten-Wallbach · Tel. (+49)6126/9453-0 · Fax -42  
Internet: <http://www.digitronic.com> · E-Mail: [mail@digitronic.com](mailto:mail@digitronic.com)

## Notification

This handbook corresponds with the unit version of 10.7.1998. The company Digitronic Automationsanlagen GmbH reserves the right to implement changes that result in an improvement of the quality and the functions of the device at any time and without any announcements.

This instructions manual was created with a maximum of care, but mistakes are not out of the question. We are thankful for any comments, regarding possible mistakes in the instruction manual.

## UP-date

You can also obtain this instruction manual on the Internet at <http://www.digitronic.com> in the latest version as PDF file.

## Qualified personal only

Commissioning and operation of the device may only be carried out by qualified personal. Qualified personal are persons, authorized with commissioning, grounding and labeling devices, systems and electrical circuits according to the applicable standards of security

## Liability

(1) The salesperson is liable for any damages for which he or the rightful owner is responsible up to the amount of the actual salesprice. Liability concerning missed profits, failed-to-appear savings, indirect damages and consequential damage is excluded.

(2) The liability restrictions above are not valid concerning assured characteristics and damages, which are caused by intention or coarse negligence.

## Protection

The device AWA/2X12B and this instruction manual are protected by copyright. All rights are reserved. Neither the device AWA/2X12B, nor this document may be copied as a whole or partially, photocopied, reproduced, translated or transferred to electronic media of any kind or into machine readable format without prior written permission by the company Digitronic Automationsanlagen GmbH.

**Note:** The products of Digitronic are so well constructed that they will not be effected by the millenium.

**Note:** This device fulfills the following norms according to electromagneticalcompatibility: EN 55011, EN 55022, EN 55024 Teil 2, EN 50082 Teil 2, ENV 50140, VDE 0843 Teil 2, VDE 0843 Teil 4, VDE 0871, VDE 0875 Teil 3 ("N"), VDE 0875 Teil 11, VDE 0877 Teil 2, IEC 801 Teil 3, IEC 801 Teil 2, IEC 801 Teil 4, IEC 801 Teil 5.



(c) Copyright 1992 - 2004 / Datei: AWA2X12E.DOC

Digitronic Automationsanlagen GmbH  
Auf der Langwies 1  
D-65510 Hünstetten - Wallbach  
Tel. (+49)6126/9453-0 Fax. (+49)6126/9453-42  
Internet: <http://www.digitronic.com> / E-Mail: [mail@digitronic.com](mailto:mail@digitronic.com)

**Table of contents**

1. Introduction .....	4
2. Assembly.....	4
3. Status LED .....	4
4. Dimensions .....	5
5. Terminal allocation .....	6
5.1. Terminal allocation of the power supply.....	6
5.2. Terminal allocation of the analog input 1 .....	6
5.3. Terminal allocation of the analog input 2 .....	6
5.4. Pin allocation of the external interface .....	6
6. Configuration.....	7
6.1. Change the input - signal level.....	7
6.1.1. Soldering bridge SJ1 .....	7
6.1.2. Soldering bridge SJ2.....	7
6.1.3. Soldering bridge SJ3 .....	7
6.1.4. Soldering bridge SJ4 .....	7
6.2. Reference voltage supply.....	7
6.3. Calibration .....	8
6.3.1. Calibration during power input .....	8
6.3.2. Calibration during voltage-input 0 - +10V.....	8
6.3.3. Calibration during voltage-input -10V - +10V .....	8
7. Technical data.....	9

## 1. Introduction

The analog - digital - converter AWA/2X12B is used as an input module for the electric camswitches of the CamCon series. The converter has two independent voltage - (-10V - +10V respective 0 - +10V) or power inputs (0 - 20mA) with a resolution of 12Bit, that can be connected via a 6 pole data cable to the external interface of the CamCon devices DC50/561, 90 and 115. By switching several devices in series connection it is possible to connect up to 5 AWA/2X12B analog digital converters.

## 2. Assembly

The device is clip-locked onto an "EN carrier rail" in the switchboard (see also chapter "6.3. Calibration" on page 8). The grounding pins and cable mantlings are to be put on the shortest way possible onto serial grounding clip next to the device. The grounded assembly plate and its electrical connection to the "EN carrier rail" allow an excellent grounding of the disturbances onto the covering. All cable connections are to be switched in a cold state ! The external interface of the CamCon (e.g. DC16/50/90 or DC115) is connected with a cable of the type: KKyy/IO-XX (yy = CamCon Type / XX = length in meters) to the plug "**external interface IN**" or "**ext.Int. IN**" on the module. Every other device is connected to the plug "**external interface OUT**" or "**ext.Int. OUT**" with a cable of the same type. The data lines of the external interface have to be galvanically separated with an optical coupler, they have to be placed and covered separately and the cover has to be grounded on both ends. Analog signals have to be placed and covered separately and the cover has to be grounded on one end. The supply voltage has to be connected separately for every module and measures 24V DC +/-20%.

example



**Note:** The analog - digital - converter has to be switched to the end of the interface row.

## 3. Status LED

The analog - digital - converter has 2 status LEDs (see also chapter 6.3. Calibration).

LED 1 indicates the presence of supply-power.

LED 2 indicates that no data exchange via a CamCon DC50, 90 or DC115CamCon is done. Possible causes are: The cable length adjusted at the CamCon outruns the maximum length of 300 meters, the CamCon DC50, 90 or DC115 is switched off, i.e. the data exchange is interrupted (broken wire).

#### 4. Dimensions

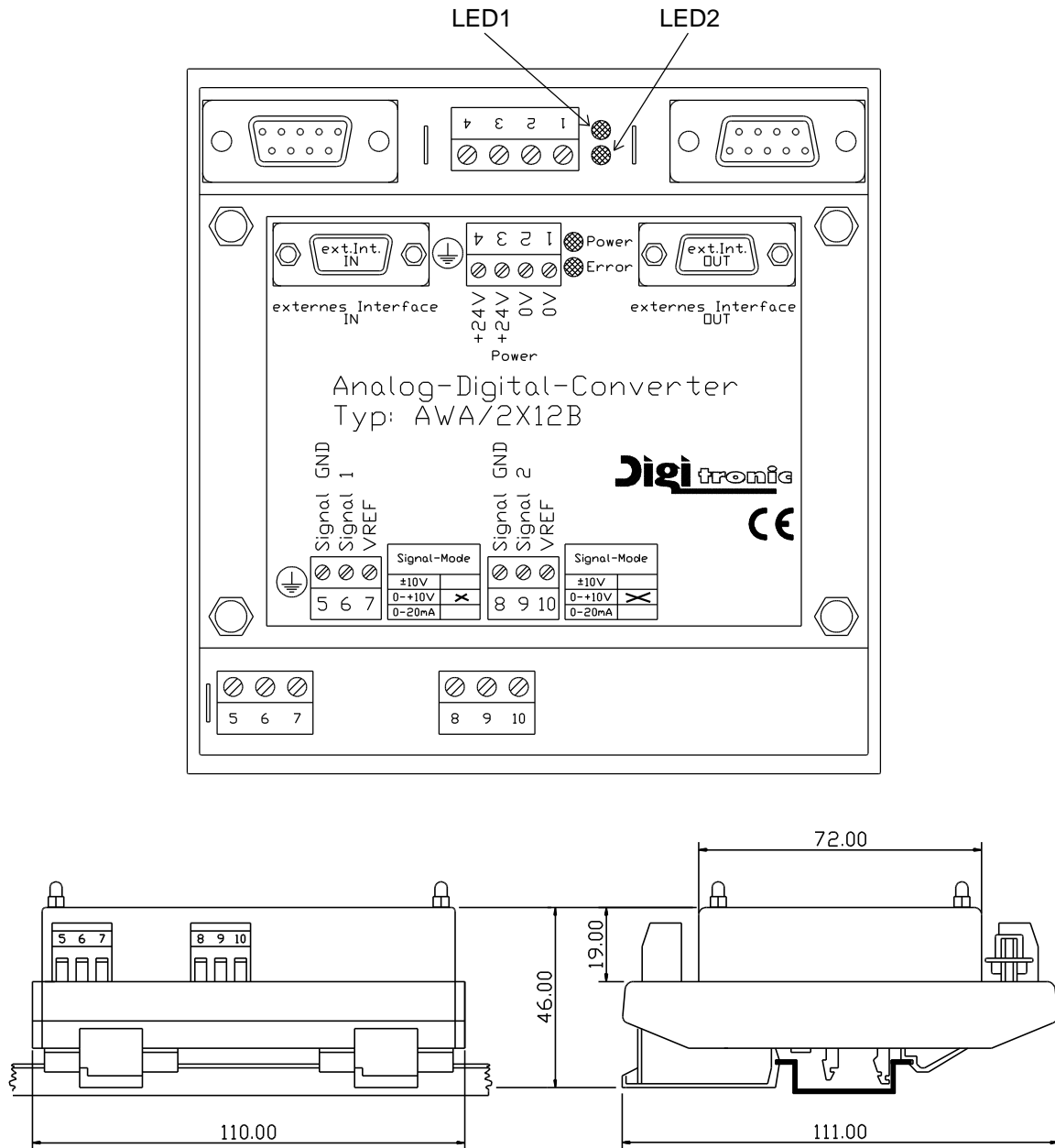

The following mounting rails may be used to assemble the case:

- NS 35 / 7.5 (DIN 50022)
- NS 35 / 15 (DIN 50022)
- NS 32 (DIN 50035)

## 5. Terminal allocation

### 5.1. Terminal allocation of the power supply

- Terminal 1 0V voltage supply
- Terminal 2 0V voltage supply
- Terminal 3 +24V voltage supply
- Terminal 4 +24V voltage supply

### 5.2. Terminal allocation of the analog input 1

- Terminal 5 signal ground GND (0V)
- Terminal 6 analog signal 1  
as voltage or current signal  
(see also chapter 6. Configuration)
- Terminal 7 reference voltage output (+4.096V or +5V)  
(see also chapter 6.2. Reference voltage supply)

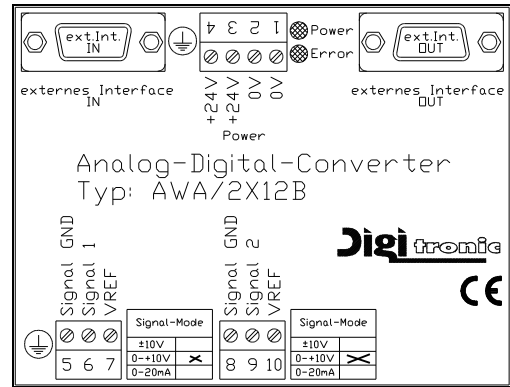

### 5.3. Terminal allocation of the analog input 2

- Terminal 8 Signal ground GND (0V)
- Terminal 9 Analogsignal 2  
as currency - or voltage signal  
(see also chapter 6. Configuration)
- Terminal 10 reference voltage output (+4.096V or +5V)  
(see also chapter 6.2. Reference voltage supply)

**Note:** All analog signals must be laid shielded and the cover has to laid to ground on both sides.



### 5.4. Pin allocation of the external interface

The analog - digital - converter AWA/2X12B has an external interface via which the data transfer with the CamCon device is done. Via the interface input the data exchange with the CamCon e.g. DC16/50/90 or DC115 is done. Via the interface output, the data exchange with another analog - digital - converter or a CamCon DC91 output-expansion is done. By this series connection several devices may be connected to a CamCon. A shielded 6 pole data cable with conductors wired in pairs is required. The maxium wiring disatance is 300 meters, the data exchange is done potentially free via optical couplers.

DSUB 9 Pin and female plug

- |           |       |       |       |       |       |
|-----------|-------|-------|-------|-------|-------|
| Pin 1,4,7 | GND   |       |       |       |       |
| Pin 2     | TxD + | Pin 8 | CLK + | Pin 5 | RxD + |
| Pin 6     | TxD - | Pin 3 | CLK - | Pin 9 | RxD - |

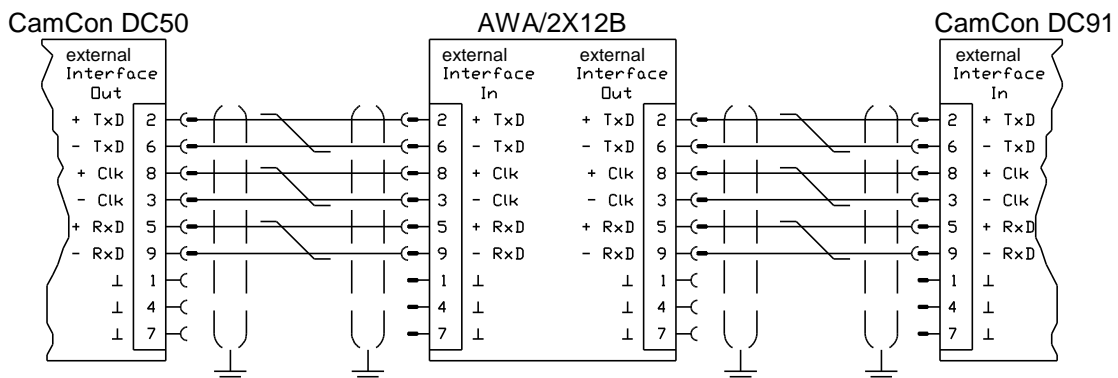

## 6. Configuration

### 6.1. Change the input - signal level

The analog inputs' signal level can be changed by soldering bridges on the solder side of the AWA/2X12B's printed circuit board.

The following input signals can be set: "0-20mA", "-10V - +10V" or "0 - +10V".

The adjusted signal level is marked for every input by with a cross on the metal cap.

To change the input level, detach all cable connections from the device., remove the device from the switch chest, open the floor part at the devices side using a screwdriver and pull the printed circuit board out of the floor part. On the soldering side of the printed circuit board are to soldering bridges for signal input 1 and 2 which are called SJ1 to SJ4 in the drawing. Via SJ1 and SJ2 the signal level for input 1 and via SJ3 to SJ4 for input 2 are set. Having adjusted the desired signal level, the input switching has to be equalized anew. See also chapter "6.3. Calibration" on page 8.

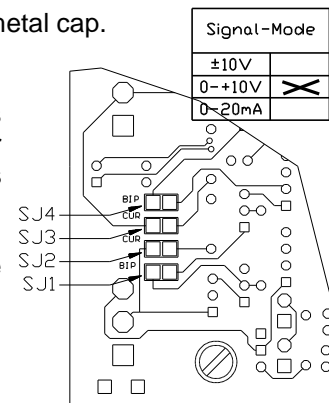

#### 6.1.1. Soldering bridge SJ1

To switch the 1st analog input from unipolar (0V - 10V) to the bipolar (-10V - +10V) voltage measuring the soldering bridge SJ1 has to be closed. This soldering bridge may only be closed, if the soldering bridge SJ2 is open.

#### 6.1.2. Soldering bridge SJ2

To switch the 1st analog input from voltage - to current input, the soldering bridge SJ2 has to be closed.

#### 6.1.3. Soldering bridge SJ3

To switch the 2nd analog input from voltage - to current input, the soldering bridge SJ3 has to be closed.

#### 6.1.4. Soldering bridge SJ4

To switch the 2nd analog input from unipolar (0V - 10V) to the bipolar (-10V - +10V) voltage measuring the soldering bridge SJ4 has to be closed. This soldering bridge may only be closed, if the soldering bridge SJ3 is open.

### 6.2. Reference voltage supply

Two internal voltages (+4.096 and +5V) are available, an external voltage source may be enabled by switching them both of. The choice is made via a jumper ledge on the component side of the printed circuit board. To change the reference voltage, remove the cap by unscrewing the four cap nuts and choose your voltage source at jumper JP1.

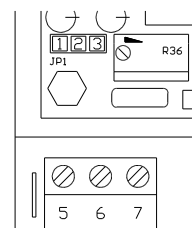

Bridge at 1+2	= +5V	Ref. voltage from the operating voltage.
Bridge at 2+3	= +4.096V	Ref. voltage by precision voltage controller (default).
Bridge open	= external	Ref. voltage external by at least +1V to a maximum of +5V.

**Note:** If the source of reference voltage is changed, the input switching has to be equilibrated anew. (see also chapter "6.3. Calibration").

### 6.3. Calibration

If the AWA/2X12B module has to be eliquibrated anew, remove the case's top by unscrewing the four cap nuts, to get to the pontentiometer. Four multi-gear trimmer are provided for this purpose. These are:

- R36 = Amplification input 1
- R37 = Offset input 1 at  $\pm 10V$  input.
- R39 = Amplification input 2
- R40 = Offset input 2 at  $\pm 10V$  input.

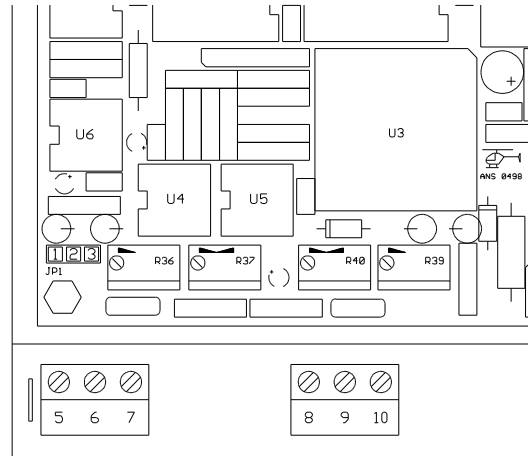

#### 6.3.1. Calibration during power input

Set a constant power source at clamps 5 and 6 for input 1 or at clamps 8 and 9 for input 2. The value of currency has to be known with great accuracy. It should be in the range of 15 to 20 mA. Now choose the menu in which this value is displayed in the device (CamCon). You are able to increase this displayed value by turning to the left at the R36 (input 1) or R39 (input 2) or de-crease it by turning to the right. Set the now present current or it's corresponding value and seal the potentiometer with sealing wax. At the potentiometers at R37 and R40 no configuration can be done while being under current.

#### 6.3.2. Calibration during voltage-input 0 - +10V

Set a voltage source to the terminals 5 and 6 for input 1 or 8 and 9 for input 2. The value of voltage has to be known with great accuracy. It should be in the range 0+5 to +10 Volt. Now choose the menu in which this value is displayed in the device (CamCon). You are able to increase this displayed value by turning to the left at the R36 (input 1) or R39 (input 2) or de-crease it by turning to the right. Set the now present voltage or it's corresponding value and seal the potentiometer with sealing wax or Tip-EX. At the potentiometers at R37 and R40 no configuration can be done while being under a voltage about 0 to +10 Volt.

#### 6.3.3. Calibration during voltage-input -10V - +10V

Bypass the terminals 5 and 6 for input 1 or 8 and 9 for input 2 using a wire with a length of 5cm and choose the menu in which this value is displayed in the device (CamCon). Now set the display-value to **0** by turning to the left or right at R37 (input 1) or R40 (input 2). Then seal the potentiometer with sealing wax or Tip-EX.

Now set a voltage source to the terminals 5 and 6 for input 1 or 8 and 9 for input 2. The value of voltage has to be known with great accuracy. It should be in the range 0+5 to +10 Volt. Now choose the menu in which this value is displayed in the device (CamCon). It should be in the range 0+5 to +10 Volt. Now choose the menu in which this value is displayed in the device (CamCon). You are able to increase this displayed value by turning to the left at the R36 (input 1) or R39 (input 2) or de-crease it by turning to the right. Set the now present voltage or it's corresponding value and seal the potentiometer with sealing wax. If the voltage source is potentially free towards the AWA/2X12B, you are able to reserve the polarity of the voltage at the terminals 5 + 6 or 8 + 9. The display now should show the negative value of the same size as it was the positive before.

## 7. Technical data

Voltage supply:.....	24VDC +-20%
Power consumption:.....	150 mA
Input ranges: .....	"0 - +10V", "-10V - +10V" or "0 - 20mA"
Input resistance	
at voltage input.....	RL = 10 kOhm
at power input:.....	RL = 220 Ohm
Resolution .....	12 Bit
Reference voltage source:.....	+4.096V (standard), +5V or extern.
Data output:.....	synchronous serial RS422
Clock frequency: .....	maximum 1 MHz minimum 100 kHz
Monoflop i.e. transforming time .....	minimum 250 µs
Grounding: .....	via 4 * 6.3mm Flatplugs directly to be laid on row- grounding pin.
Assembling .....	simply clamp upon carrier rail according to EN 50 022, may be set in rows. The following mounting rails may be used to fasten the case: NS 35 / 7.5 (DIN 50022) NS 35 / 15 (DIN 50022) NS 32 (DIN 50035)
Disassembly.....	by pulling back the snapping bars
Protection.....	Type of case: Phoenix UM corresponds to IP20 and cap made of 1mm galvanized tin.
Dimensions: .....	See also chapter 6.3. Calibration.
Working temperature .....	0°C to + 50° C
Weight:.....	apprxoximately 400g