

**Digital Cam Switch Unit**

# CamCon DC33/X

with 8 programs



## **Digitronic Automationsanlagen GmbH**

Steinbeisstraße 3 · D - 72636 Frickenhausen · Tel. +49 7022 40590-0 · Fax -10  
Auf der Langwies 1 · D - 65510 Hünstetten-Wallbach · Tel. +49 6126 9453-0 · Fax -42  
Internet: <http://www.digitronic.com> · E-Mail: [mail@digitronic.com](mailto:mail@digitronic.com)

### For your attention

This instruction manual relates to the CamCon DC33/X from Nov. 1996. The company Digitronic Automationsanlagen GmbH reserves the right to make changes which present an improvement of the quality or functionality of the device without prior notice. The instruction manual was created with great care, although it may not be error-proof. We would be grateful for any communication relating to any errors you may have found.

### Update

You can also obtain this instruction manual on the Internet at <http://www.digitronic.com> in the latest version as PDF file.

### Qualified personnel

This device may only be started and operated by qualified staff. By qualified we mean personnel who are entitled to handle, to earth and to label devices, systems and power circuits in accordance with the technology safety standards.

### Liability

(1) The supplier is liable for damages caused by himself or by the owner of the rights up to the sum of the sales price. He is not liable for loss of profits, forfeited savings, intermediate and successive damages.

(2) The above mentioned limits to liability do not apply to insurance of named characteristics and damages which were caused deliberately or through negligence.

### Protection

The CamCon DC33/X and this instruction manual are protected by copyright. All rights are reserved. Neither the CamCon DC33/X, nor this document may be copied as a whole or partially, photocopied, reproduced, translated or transferred to electronic media of any kind or into machine readable format without prior written permission by the company Digitronic Automationsanlagen GmbH.

**Note:** We have examined the devices of the CamCon series for year 2000 compatibility and have not found any adverse effects on any functions.

**Note:** CamCon is a registered trademark of the company Firma Digitronic Automationsanlagen GmbH.

**Note:** The devices of the CamCon series comply with the standards for electromagnetic compatibility: EN 55011, EN 55022, EN 55024 Part 2, EN 50082 Part 2, ENV 50140, VDE 0843 Part 2, VDE 0843 Part 4, VDE 0871, VDE 0875 Part 3 ("N"), VDE 0875 Part 11, VDE 0877 Part 2, IEC 801 Part 3, IEC 801 Part 2, IEC 801 Part 4, IEC 801 Part 5.



(c) Copyright 1992 - 2009 / File: DC33X\_E.DOC

Digitronic Automationsanlagen GmbH  
Auf der Langwies 1  
D-65510 Hünstetten - Wallbach  
Tel. (+49)6126/9453-0 Fax. (+49)6126/9453-42  
Internet: <http://www.digitronic.com>  
E-Mail: [mail@digitronic.com](mailto:mail@digitronic.com)

## TABLE OF CONTENTS

1. Introduction .....	5
2. Operating Principles .....	6
2.1. Speed Compensation .....	7
2.1.1. Measuring delay time for Speed Compensation .....	9
2.1.1.1. Measuring delay time through actual differences .....	9
2.1.1.2. Measuring delay time by means of different measuring points .....	9
3. Installation .....	10
3.1. Dimensions .....	10
4. Electrical connections .....	11
4.1. Pin allocation CamCon with 16 outputs and 8 programs .....	11
4.2. The encoder .....	12
4.3. The outputs .....	12
4.4. External program selection .....	12
4.5. External activation of the keyboard lock .....	12
4.6. Precautions to be taken at welding operations .....	12
5. Outline of the operator terminal .....	13
5.1. Frontview CamCon .....	13
5.2. The output display .....	13
5.3. The seven-segment display .....	13
5.4. The keyboard .....	13
5.4.1. Display of position and speed .....	13
6. Commissioning .....	14
6.1. Complete deletion .....	14
6.2. Initialization .....	14
6.2.1. User keys for the system registers .....	14
6.2.2. The encoder resolution .....	15
6.2.3. The F/R change over .....	15
6.2.4. The zero point correction .....	15
6.2.5. Setting of the programming mode .....	15
6.3. The dead time compensation .....	15
6.4. Cam programming in programming mode "0" .....	16
6.4.1. Selecting a program .....	16
6.4.2. Selecting an output .....	16
6.4.3. Searching for cams .....	16
6.4.4. Setting the preset value .....	16
6.4.5. Shifting the activation point .....	16
6.4.6. Shifting the deactivation point .....	17
6.4.7. Leaving cam programming .....	17
6.4.8. Examples for cam programming in the programming mode "0" .....	18
6.4.8.1. Programming the first cam .....	18
6.4.8.2. Programming additional cams on an output .....	19
6.4.8.3. Deletion of a particular cam .....	20
6.5. Cam programming in programming mode "1" .....	21
6.5.1. Selecting a program .....	21
6.5.2. Selecting an output .....	21
6.5.3. Shifting the activation point .....	21
6.5.4. Shifting the deactivation point .....	21
6.5.5. Leaving cam programming .....	22

6.5.6. Examples for cam programming in the programming mode "1" .....	22
6.5.6.1. Cam programming .....	22
6.5.6.2. Deletion of cams .....	22
7. Outline of operations .....	23
7.1. Switching the standard display .....	23
7.2. Programming the system constants .....	23
7.3. Dead time programming .....	23
7.4. Cam programming .....	23
8. watch doc .....	24
9. Troubleshooting .....	24
10. Technical data of the CamCon .....	25
11. Keyword table .....	26

## 1. Introduction

Electronic Cam Switch Units have been successfully used in industry for a long time. Experiences collected in close liaison with users over the years have been included in the development of the CamCon series. The result is a compact digital cam switch unit which is user friendly and reliable to a high degree. The following characteristics testify the excellence of the CamCon:

- \* Tested and reliable hardware
- \* Short-circuit-proof outputs
- \* Graphic liquid crystal display with 128x64 pixels in the CamCon DC50,51.
- \* Large and clearly visible 7-Segment display for program, position and speed on CamCon DC30,33 and 40.
- \* Any number of cams per output can be programmed.
- \* Up to 32000 Programs for product administration
- \* Master, for example: machine cams
- \* Optimising switch points when machine is in operation
- \* Compensation of mechanical delay time of switch components for switch-ON and switch-OFF points can be set in steps of 100µs separately (DTC = delay time or Speed Compensation).
- \* Not linear Speed Compensation (NLT).
- \* Position - Triggert - Time - Cams
- \* Power supply 24V DC +/- 20%
- \* Mounting of suspension rails to EN 50022 on CamCon DC16 and 90
- \* Switchboard panel standard casing 144 x 144 x 63mm to DIN 43700 on CamCon DC33,40 and 51
- \* S5 Components group for S5 115U, 135U and 155U on CamCon DC115
- \* S7 Components group for S7 300 on CamCon DC300
- \* AB Components group for ControlLogix<sup>®</sup> 1756 on CamCon 1756-DICAM
- \* S5 Switch-ON via PG interface with L1 - Bus on CamCon DC16,40,50,51 and 90
- \* PLC Logic Module (optional)
- \* Shift register (optional)
- \* OP - Functions
- \* Analog outputs (optional)

Cam switch units are used wherever switching operations are periodically repeated. Digital cam switch units are an optimum replacement of mechanical units and offer in addition many other advantages, such as:

- \* Simplification of mounting and adjustment operations
- \* Repeatable adjustment facility
- \* Standardised for almost all areas of application
- \* Reliability
- \* High switch speed
- \* Speed Compensation
- \* Product administration for quick format change

## 2. Operating Principles

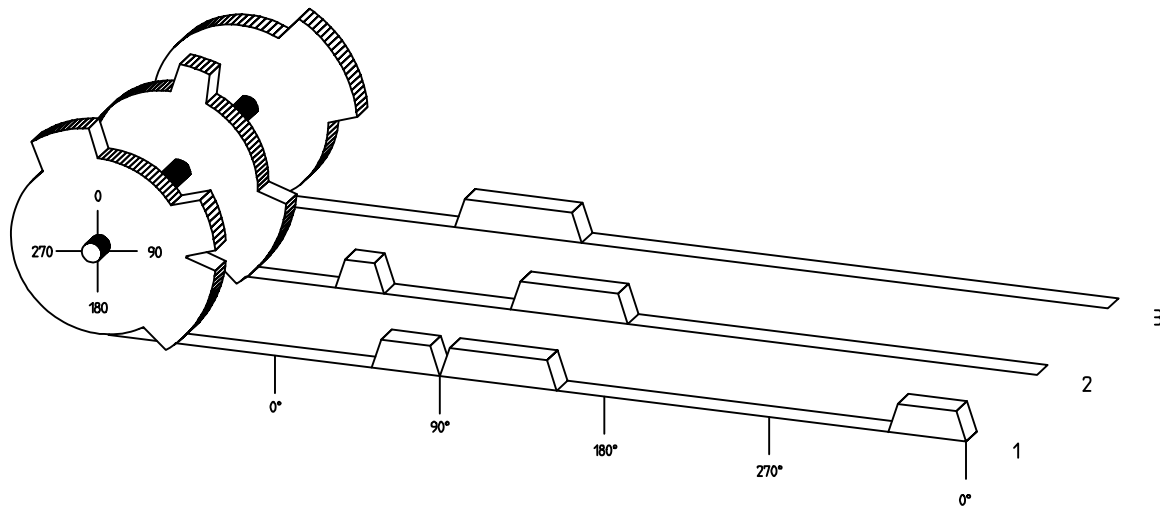

Diagram: Principles of a Cam Switch Unit

A principle for better comprehension of the function of a Cam Switch Unit is here presented. It has 3 outputs with the following cams:

Output 1:	Cam 1:	Switch-ON position	60°	Switch-OFF position	85°
	Cam 2:	Switch-ON position	95°	Switch-OFF position	145°
	Cam 3:	Switch-ON position	325°	Switch-OFF position	355°
Output 2:	Cam 1:	Switch-ON position	5°	Switch-OFF position	20°
	Cam 2:	Switch-ON position	95°	Switch-OFF position	145°
Output 3:	Cam 1:	Switch-ON position	30°	Switch-OFF position	85°

The positions of the output signals, here presented as three tracks, occur when the three cam disks turn anti-clockwise past a sensor, which scans the cams on the 0°-axis.

In a mechanical cam switch unit, the switch interval, i.e. the range between switch-ON and switch-OFF position are determined by the length of the cam. The length and the position of the cam can only be varied marginally and this is mechanically highly demanding and time consuming. With CamCon such adjustments can be realised in a fraction of time; in addition, there can be any number of tracks. A measuring system which is fitted to the device reports the position to the CamCon. The CamCon compares it with the programmed switch-ON and Switch-OFF positions of all outputs. If the position lies in the range of a programmed switch-ON / switch-OFF position (cam), then the respective outputs are active.

## 2.1. Speed Compensation

Each mechanical switch component (e.g. shield, magnetic valve) has a delay time, i.e. the time between the start signal and the actual switching of the contacts. In processes where positioning is executed on a moving system, this can cause problems. If such a process is driven with different speeds, different positions are caused. To avoid this happening, new timings for the switch signals of each speed would have to be calculated.

In order to illustrate the complicated issues surrounding delay time or speed compensation, this will be shown on the example of a packaging machine. In the process shown in the diagram, a glue point has to be placed in an exactly defined spot on a moving paper track.

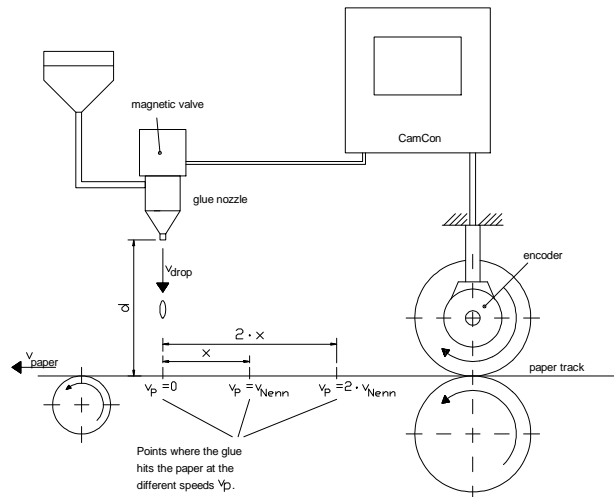

The system has the following parameters:

- $v_p$  - Speed of the paper track
- $v_T$  - Falling speed of the drop of glue
- $d$  - Distance between the glue nozzle and the paper track
- $T_{MV}$  - Delay time of the magnetic valve

Without speed compensation the following would happen:

As soon as the measuring system has reached a certain position, the CamCon sends a signal to the magnetic valve. The glue nozzle opens for a short time during which a drop of glue ejects. Between the start of the impulse and the exit of the drop time passes, which is mainly caused by the delay time of the magnetic valve  $T_{MV}$ . A further delay is caused by the time which the droplet needs to pass the distance between the glue nozzle and the surface of the paper.

This flight time is calculated as follows:

$$t_{\text{Flight}} = \frac{d}{v_T}$$

In total there the delay time is  $t_{\text{Flight}} + T_{MV}$ . During this time the paper track moves on by a specific distance  $x$ .

It would now be possible to move the position, where the magnetic valve is switched on, forward by a specific amount, so that the glue droplet hits the same spot again as during standstill. In this way a speed compensation is created which works only at a specific speed of the paper. As soon as the speed of the device and consequently that of the paper track is, for example, doubled, the hit point of the glue droplet is shifted by the distance  $x$ , so that, without any speed compensation, it would move backward by double the distance ( $2 \cdot x$ ) in total.

The automatic speed compensation of the CamCon makes it now possible to drive processes with variable speed; CamCon registers the speed of the device continuously and adjusts the cams which determine the switch time points "On Line" depending on the speed. This has the effect that the outputs for the switch components are switched ON or OFF earlier. The direction of the movement is of no significance in this instance.

A small example in figures was designed to elucidate:

Supposing the drive cylinder with the measuring system has a circumference of 360mm, so that one millimeter of the circumference corresponds to exactly one angle degree of the measuring system.

The device has the following parameters:

$$\begin{aligned}v_{\text{droplet}} &= 20\text{m/s} \\d &= 20\text{cm} \\T_{\text{MV}} &= 20\text{ms}\end{aligned}$$

This results in the following flight time of the droplet:

$$t_{\text{Flight}} = \frac{d}{v_T} = \frac{0,2\text{m}}{20\text{m/s}} = 10\text{ms}$$

The total delay time is then  $T_{\text{dead, altogether}} = T_{\text{MV}} + t_{\text{Flight}} = 20\text{ms} + 10\text{ms} = 30\text{ms}$

During this time the paper track moves on by the distance  $x = v_{\text{paper}} \cdot T_{\text{total delay}} = 1\text{m/s} \cdot 30\text{ms} = 30\text{mm}$ . In order to compensate the delay time, the switch point for the magnetic valve must be moved forward by  $30^\circ$ .

If the speed of the device and consequently that of the paper is doubled  $v_{\text{paper}}$ , then the distance  $x$  is also doubled by the speed of the paper track. In this case the switch point must be moved by  $60^\circ$ .

**Note:** Please take into account in these explanations that delay time is of a fixed size, which is determined by the mechanical constants of the set and switch components and by the dimensions of the construction and therefore does not change!

If the total delay time of 30ms was programmed into the respective output of CamCon, then the glue droplet would always hit the right spot, regardless of the speed.

### 2.1.1. Measuring delay time for Speed Compensation

Several ways of measuring delay time of a relay or valve are available.

#### 2.1.1.1. Measuring delay time through actual differences

First the switch-ON point of a valve or relay is programmed. We assume that the programmed switch point lies at 200 degrees in this case. If the machine is driven with a speed of for example 40 rpm, a shift occurs due to delay time. This shift is then measured and, in this example, will amount to 40 degrees.

**Warning:** For the calculation of the shift the programmed delay time in the cam switch unit must be set to zero!

The delay time of the switch component is now calculated as follows:

$$\text{Delay time ( in sec. )} = \frac{\Delta \text{ way (in } ^\circ \text{)} * 60 \text{ (sec./min.)}}{\text{speed (in rpm)} * 360 \text{ (}^\circ\text{/turn)}}$$

$$\text{Delay time ( in sec. )} = \frac{40 * 60}{40 * 360} = 0.1667 \text{ sec.}$$

The resultant delay time is then entered into the cam switch unit.

See Chapter "6.3. The dead time compensation" an page 15.

#### 2.1.1.2. Measuring delay time by means of different measuring points

First the switch point is calculated at a speed of, for example, 50 rpm. We assume that the programmed switch point lies at 200° in this case. The second measurement is taken at a speed of 80 rpm. The necessary switch point must be set to 160°, if the exact switch point is to be also achieved at 80 rpm.

**Warning:** For the calculation of the two switch points the programmed delay time in the cam switch unit must be set to zero!

The delay time of the switch component is then calculated with the following formula:

$$\text{Delay time ( in sec. )} = \frac{\Delta \text{ way (in } ^\circ \text{)} * 60 \text{ (sec./min.)}}{\Delta \text{ speed (in rpm)} * 360 \text{ (}^\circ\text{/turn)}}$$

$$\text{Delay time ( in sec. )} = \frac{40 * 60}{30 * 360} = 0.222 \text{ sec.}$$

The resultant delay time is then entered into the cam switch unit.

See Chapter "6.3. The dead time compensation" an page 15.

Since the entered delay time shifts the switch point, the previously programmed cam must be changed. For the calculation of the exact switch-ON position, the difference to the speed 0 rpm (here using 50 rpm) must be added to the first measured switch-ON point (here 200°). The difference is calculated with the following formula:

$$\Delta \text{ way (in degrees)} = \frac{\text{dead time ( in sec. )} * \Delta \text{ time (in min}^{-1}\text{)} * 360 \text{ (degrees/rotations)}}{60 \text{ (sec./min.)}}$$

$$\Delta \text{ way (in degrees)} = \frac{0.222 * 50 * 360}{60} = 66.6 \text{ degrees}$$

The switch-ON point of the cam is now shifted from 200° by approx. 67° to 267°.

### 3. Installation

The unit is inserted into a cutout for front plate installation (see chapter "3.1. Dimensions" on page 10). Connect the grounding pins on the back of the encasement as well as the cable cover to a grounding point of the switchboard door in the shortest possible way. All cable connections must be done in a cold state! The connection cables, e.g. for the measuring system or the serial interface, must be wired with covers, and the covers have to be grounded on both ends. Analog signals must also be wired with covers, and the covers have to be grounded on one end.

#### 3.1. Dimensions

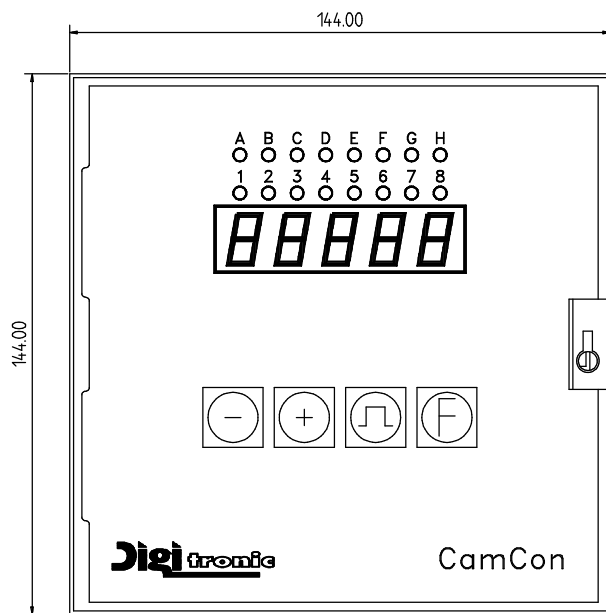

cutout as per DIN 138 +1 x 138 +1

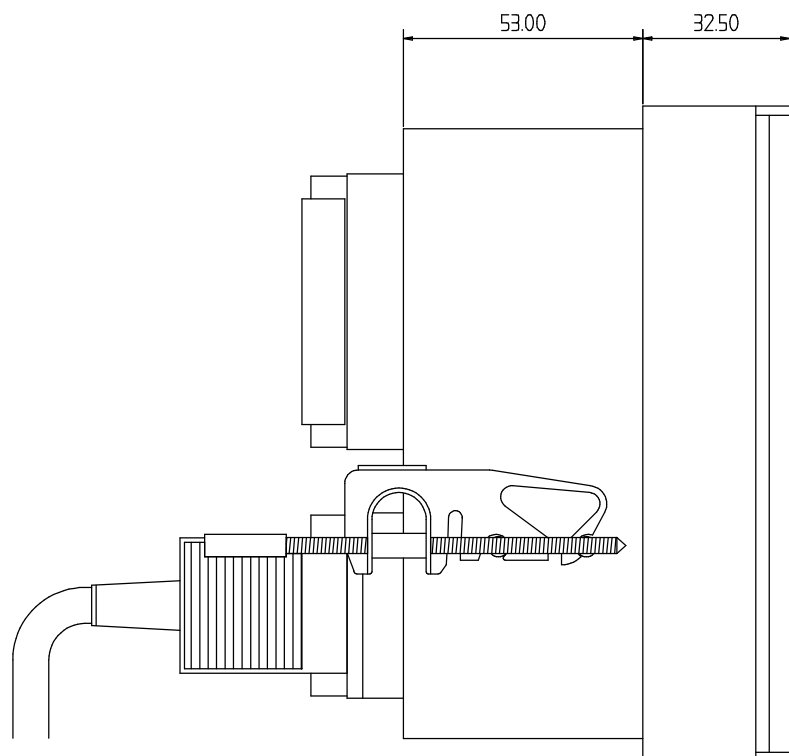
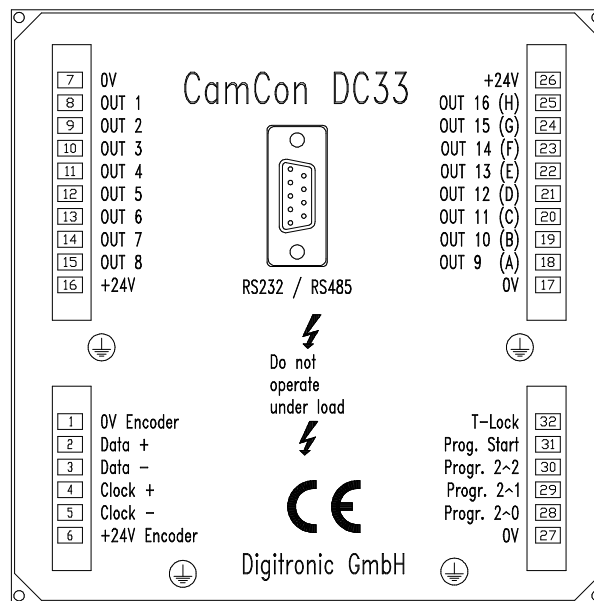

Fig.: Drawing to aid the installation of CamCon

#### 4. Electrical connections



#### 4.1. Pin allocation CamCon with 16 outputs and 8 programs

- Pin 1: 0V for encoder
- Pin 2: Data A or +
- Pin 3: Data B or -
- Pin 4: Clock A or +
- Pin 5: Clock B or -
- Pin 6: +24V DC for encoder
  
- Pin 7: 0V supply
- Pin 8: Output 1
- Pin 9: Output 2
- Pin 10: Output 3
- Pin 11: Output 4
- Pin 12: Output 5
- Pin 13: Output 6
- Pin 14: Output 7
- Pin 15: Output 8
- Pin 16: +24V DC supply
  
- Pin 17: 0V supply
- Pin 18: Output 9 (A)
- Pin 19: Output 10 (B)
- Pin 20: Output 11 (C)
- Pin 21: Output 12 (D)
- Pin 22: Output 13 (E)
- Pin 23: Output 14 (F)
- Pin 24: Output 15 (G)
- Pin 25: Output 16 (H)
- Pin 26: +24V DC supply
  
- Pin 27: 0V for program selection
- Pin 28: Input 1 ( $2^0$ ) for program selection
- Pin 29: Input 2 ( $2^1$ ) for program selection
- Pin 30: Input 4 ( $2^2$ ) for program selection
- Pin 31: Input for the program number transfer
- Pin 32: Input for the activation of the keyboard lock

## 4.2. The encoder

The encoder is used for getting the actual position, necessary for the cam controller. Only encoders with an SSI interface can be connected to CamCon DC33/X. The SSI interface is a common interface for absolute single and multiturn encoders. The CamCon supplies the measuring system with 24Volt via this interface. To read the data, CamCon sends a clock signal with an RS422 level to the encoder. The encoder answers synchronously with the output (data) of the position in Gray code. The frequency of the clock signal depends on the length of the cable connecting encoder and CamCon. The cable length can be maximum of 200 metre.

**Note:** The data protocol corresponds with the Stegmann SSI Norm.

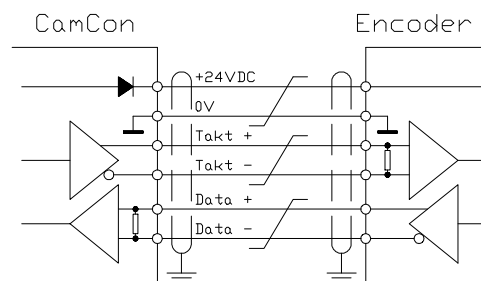
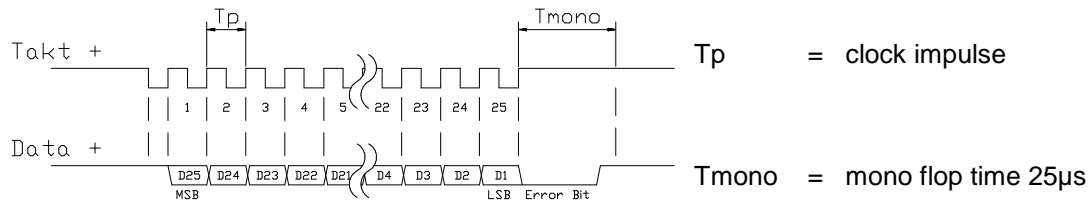

### Attention:

Use only a covered double entwined connection cable. The wiring should not be near power current lines. Ground the covers at both sides.

## 4.3. The outputs

CamCon is equipped with either 8 or 16 short circuit-proof outputs, depending on the version. They emit 24V high active signals and are not potentially free. They supply up to 500mA permanent current in a surrounding temperature of 25°C. If an output short circuits or overloads, the device switches off with the "A-Err" message.





**Attention:** With inductive loads the outputs have to be switched with free wheeling diodes.

## 4.4. External program selection

The CamCon offers the possibility to select the desired program number externally, through special outputs. To do this you have to enter the program number as a binary digit at the pins for the external program selection (pins 28, 29 and 30). With an impulse (+24V), that has to be entered at least 20ms after the program number and that has to be at least 20ms long, the program is selected at the input for the program number transfer (pin 31).

## 4.5. External activation of the keyboard lock

A signal (+24V DC) at the input for the activation of the keyboard lock (pin 32) disables the keys  and . This makes it impossible to initialize or program the device.

## 4.6. Precautions to be taken at welding operations

For the duration of welding operations carried out at the machine, the connecting wires concerning the data exchange from the measuring system to the CamCon and the power supply as well as the grounding connections and inputs and outputs have to be separated from the CamCon.

## 5. Outline of the operator terminal

### 5.1. Frontview CamCon

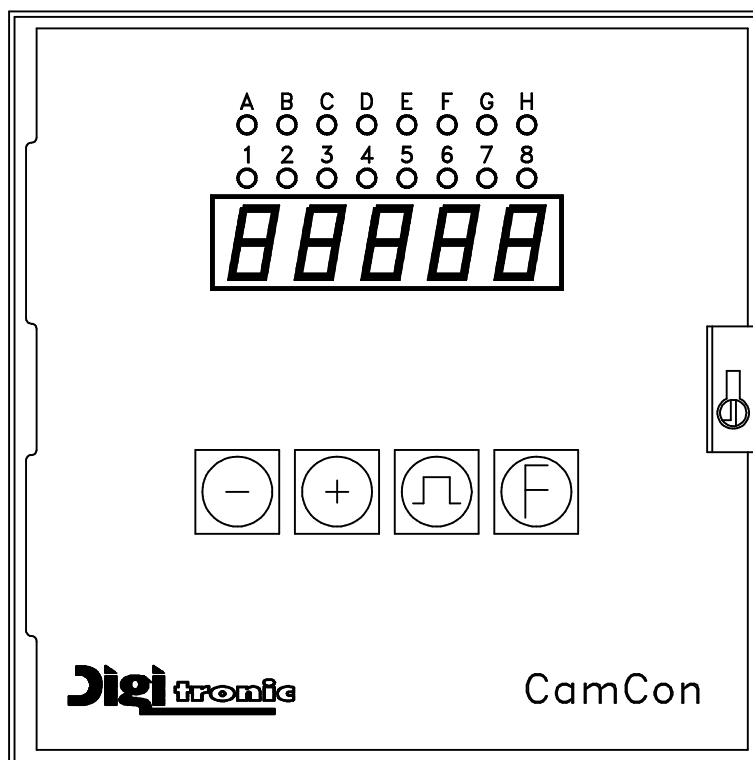

### 5.2. The output display

The output display shows the current states of the outputs. If a LED is illuminated, the corresponding output is active.

### 5.3. The seven-segment display

This display is divided into two ranges. The 1. and the 2. segment show the current mode of CamCon, and the segments 3, 4 and 5 display the value pertaining to this mode.

### 5.4. The keyboard

The **+** key serves for increasing the input values by the value one. If you keep the **+** key pressed for about two seconds, the input values will increase automatically until released.

The **-** key is used to reduce the input values by the value one. Keeping the **-** key pressed for about two seconds will cause the input values to decrease automatically until the release of the **-** key.

The **□** key serves for the initiation of the programming mode and/or for the modification of the input type.

The **F** key is used for the initiation of the system mode, for the selection of the system constants and/or for selecting the outputs in the programming mode.

#### 5.4.1. Display of position and speed

After the activation and after having left the programming modes the 7-segment display shows the current program number and the rotatory speed in rotations/minute. By pressing the **+** key, the angular position of the encoder, e.g.  $P \quad | \quad 2 \quad 3$  is displayed. If the **-** key is pressed, the display will show the current program number and the rotatory speed.

## 6. Commissioning

Before activating the device for the first time, please check its wiring (see chapter 4. Electrical connections).



**Attention:** *With induced loads the outputs have to be switched with a freewheeling diode. Covers or inductivities very close to the device inside the switchboard have to be switched with a deletion unit as do those that are wired to or influence the wiring of the device.*

### 6.1. Complete deletion

After the first activation of the supply voltage the program memory is not in an initialized mode. This leads to the CamCon's display showing uncomprehensible symbols. That is why you (at the first activation of your CamCon) have to put a complete deletion into process as follows:

1. Activate the device (supply with voltage, +24V DC).
2. Wait until the display shows either a number or  $\bar{\square} - \bar{\square} \bar{\square} \bar{\square}$ .
3. Press the  $\bar{\square}$  key four times.
4. Press the  $\bar{\square} +$  key four times.
5. Press the  $\bar{\square} F$  key (about 2sec.), until  $\bar{\square} \exists \bar{\square} \bar{\square}$  is displayed.
6. Press the  $\bar{\square} \bar{\square}$  key (about 2sec.), until the display goes out.
7. Release the  $\bar{\square} \bar{\square}$  key.

After a while (up to 40sec.) the display is reactivated. This completes the complete deletion. All cams are erased, and all system registers have the standard value.

### 6.2. Initialization

After an activation of the voltage supply or a complete deletion the CamCon is in the standard mode. This mode normally displays the rotational speed, the angular position of the encoder, or an error message. The error message continues to be displayed until the system registers have been adjusted to the encoder, provided the wiring is correct.

#### 6.2.1. User keys for the system registers

In order to be able to program the system registers, the following key sequence must be maintained:

1. Press the  $\bar{\square}$  key four times.
2. Press the  $\bar{\square} +$  key four times.
3. Keep the  $\bar{\square} F$  key pressed for about 2 seconds, until the display shows  $\bar{\square} \exists \bar{\square} \bar{\square}$ .

### 6.2.2. The encoder resolution

The display  $\square \square \square \square$  shows the resolution of the encoder in steps per rotation. The CamCon operates with a standard encoder with a resolution of 360 steps per rotation. The resolution cannot be adjusted or changed.

### 6.2.3. The F/R change over

After pressing the  $\square$  key the display shows  $\square \square \square \square$ . The display  $\square \square \square \square$  shows that the encoder is counting upwards clockwise, when looking at the shaft. You can reverse the rotational direction of the encoder by pressing the  $\square$  or the  $\square$  key.  $\square \square \square \square$  is displayed.

### 6.2.4. The zero point correction

If you press the  $\square$  key, the display shows e.g.:  $\square \square \square \square$ . **123** represents the current angular position of the encoder. After having positioned the drive to mechanical "0", you can also shift the current angular position to "0" by pressing the  $\square$  key or the  $\square$  key, so that the mechanical and the electronic zero point coincide. The display shows  $\square \square \square \square$ .

### 6.2.5. Setting of the programming mode

$\square \square \square \square$  appears on the display after you press the  $\square$  key. Here you can set the mode for cam programming. Pressing either the  $\square$  or the  $\square$  key results in a change over from programming mode 0 to programming mode 1. The programming mode 1 is easier to use than the programming mode 0, but it is not possible (in programming mode 1) to program several cams on one output.

You can return to the standard display with an additional pressing of the  $\square$  key. CamCon should now display the current speed, e.g.:  $\square \square \square \square$ . If not, please refer to the chapter "Troubleshooting".







## 6.3. The dead time compensation

Keeping the  $\square$  key pressed (for about 2 sec.) in the standard display mode lets the display show  $\square \square \square \square$ . Here you can enter the dead time for output 1 in the range of 0ms to 255ms. By pressing the  $\square$  key or the  $\square$  key, you can change this value in steps of 1 ms. By pressing the  $\square$  key shortly, you can proceed to the next output, and so on. The display shows e.g.  $\square \square \square \square$ . This way you can enter time factors for every single output, so that they are (de)activated earlier. You can abort the programming of the dead time compensation at all times by pressing the  $\square$  key.







## 6.4. Cam programming in programming mode "0"

### 6.4.1. Selecting a program









The cam programming and the program selection are initiated as follows:

Press the  for about 2 seconds, until the display shows e.g.:  .  .  means that e.g. program 0 is currently selected. By pressing the  or the  key, you have the possibility to select a program of 0 to 7. When the desired program number is adjusted, you can exit the 'Cam programming' mode by pressing the  key.





### 6.4.2. Selecting an output

To initiate cam programming press the  key for about 2 seconds, until the display shows e.g.:  . Press the  key again; the display shows e.g.:  . This indicates that there is no programmed cam on output 1 in the 'Output selection' mode. By pressing the  key or the  key you can now select the output on which you want to program cams.





### 6.4.3. Searching for cams



By pressing the  key you leave the 'Output selection' mode  and enter the mode 'Cam search'  . In the 'Cam search' mode  you can search for the cam activation points by pressing the  key. Every time the  key is pressed, CamCon searches the memory for activation points of the cams on the corresponding output. If no cam has been programmed,  is displayed. If a cam has been programmed over the whole perimeter, the display shows  .

### 6.4.4. Setting the preset value









You leave the 'Cam search' mode  and enter the 'Preset' mode  with the pressing of the  key. By pressing the  or the  key you can now select a value, e.g. 100. This value is the originator from which cams may either be reconstructed or erased by changing the activation and the deactivation points.







### 6.4.5. Shifting the activation point

By pressing the  key you leave the 'Preset' mode  and enter the 'Activation point' mode  . A pressing of the  key or the  key shifts the activation point by one step. This is done according to the following system:



A short single pressing of the  key will erase the activation point at the previously displayed preset value, e.g. 100, and then the preset value is increased by 1, e.g. to 101. A short pressing of the  key will lower the preset value (100 in our example) by 1 and then set a new activation point at e.g. 99.

#### 6.4.6. Shifting the deactivation point

Pressing the  key once more leads you from the 'Activation point' mode  into the 'Deactivation point' mode . CamCon will first search for the deactivation point of the current cam (e.g.:   ). By pressing the  or the  key the deactivation point is shifted by one step. This is done according to the following system:

A single short pressing of the  key will set a new switching point at the previously displayed preset value, e.g. 100. Then the preset value is increased by one, e.g. to 101. A short pressing of the  key will lower the preset value, e.g. 100, by 1 and then delete the switching point 99. The new deactivation point is then 99. A further pressing of the  key brings you back to the 'Output selection' mode   .

#### 6.4.7. Leaving cam programming

No matter in which programming mode you are, you can always leave cam programming by pressing the  key. The standard display appears  .













## 6.4.8. Examples for cam programming in the programming mode "0"

### 6.4.8.1. Programming the first cam

#### Task:

After a complete deletion of the program memory and a successful initialization of the system, a cam shall be programmed in program 0 for output 2 from 100 to 200.



#### Solution:

1. Press the  key (for about 2 sec.), until you enter the 'Program selection' mode: P A 0.
2. Press the  key (for about 2 sec.), you enter the 'Output selection' mode | 0 \_ \_ \_ .
3. Press the  key to select output 2, 2 0 \_ \_ \_ .
4. Press the  key, you enter the 'Cam search' mode 2 0 \_ \_ \_ .
5. Press the  key, for the input of the preselection 2 1 1 | .
6. Press the  key and keep it pressed until 2 1 1 | 0 0 is displayed.
7. If you have released the  key too early or too late, you can adjust the preselection to 100 with the  or the  key.
8. Press the  key, the activation point is displayed.
9. Press the  key to program the deactivation point.
10. Press the  key and keep it pressed until the display shows 2 L 2 0 0 .

**CAUTION!** Do not keep the key pressed too long. It is best to keep the  key pressed until 190 and then adjust to 200 step by step.

11. Press the  key. You return to the standard display.

#### NOTE:











When programming the activation and the deactivation points you are programming "on line", i.e. if you keep the  key pressed for too long, the cam will be programmed too long. Although you can correct this subsequently with the  key, the range between the desired end of the cam and cams entered in excess is erased. All cams already programmed in this range are lost.

### 6.4.8.2. Programming additional cams on an output

#### Task:

A cam shall be programmed in program 0, on output 2 from 300 to 330 in addition to an already existing cam, e.g. from 100 to 200.



#### Solution:

1. Press the  key (for about 2 sec.), until you enter the 'Program selection' mode: P A 0.
2. Press the  key (for about 2 sec.), you enter the 'Output selection' mode | 0 \_ \_ \_.
3. Press the  key to select output 2, 2 0. | 0 0. The display also shows the begin of the already programmed cam.
4. Press the  key, you enter the 'Cam search' mode 2 0 | 0 0.
5. Press the  key for the input of the preselection 2 1 | 0 0.
6. Press the  key and keep it pressed until 2 1 3 0 0 appears on the display.
7. If you have released the  key too early or too late, you can adjust the preselection to 300 with the  or the  key.
8. Press the  key, the activation point is displayed.
9. Press the  key to program the deactivation point.
10. Press the  key and keep it pressed until 2 L 3 3 0 is displayed.

**CAUTION!** Do not keep the key pressed too long. It is best to keep the  key pressed until 320 and then adjust to 330 step by step.

11. Press the  key. You return to the standard display.

#### NOTE:









When programming the activation and the deactivation points you are programming "on line", i.e. if you keep the  key pressed for too long, the cam will be programmed too long. Although you can correct this subsequently with the  key, the range between the desired end of the cam and cams entered in excess is erased. All cams already programmed in this range are lost.

### 6.4.8.3. Deletion of a particular cam

#### Task:

You want to delete the cam from 300 to 330 in program 0, on output 2.

#### Solution:

1. Press the  key (for about 2 sec.), until you enter the 'Program selection' mode: P A 0.
2. Press the  key (for about 2 sec.), you enter the 'Output selection' mode | 0 \_ \_ \_.
3. Press the  key to select output 2, 2 0 1 0 0. The start of the first cam found is displayed.
4. Press the  key, you enter the 'Cam search' mode 2 0 1 0 0.
5. Press the  key, the device searches for the start of the next cam. 2 0 3 0 0 is displayed.
6. Press the  key. The preselection 2 0 3 0 0 is displayed.
7. Press the  key to program the activation point. The display shows 2 0 3 0 0.
8. Press the  key and keep it pressed until the display shows 2 0 3 3 0.

**CAUTION!** Do not keep the key pressed too long. It is best to keep the  key pressed until 320 and then adjust to 330 step by step.

9. Press the  key. You return to the standard display.





#### NOTE:

By shifting the cam activation point to the cam deactivation point the programmed cam is deleted. By shifting the activation point beyond the deactivation point deletes the range after the cam (e.g. from 330 to 350). All cams programmed in this range are deleted. A new cam will be placed between 330 and 350 when you move the activation point back to the desired position of 330 !

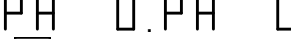

## 6.5. Cam programming in programming mode "1"

### 6.5.1. Selecting a program



The cam programming and the program selection are initiated as follows:

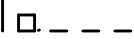

Press the  for, about 2 seconds, until the display shows e.g.:  means that e.g. program 0 is currently selected. By pressing the  or the  key, you have the possibility to select a program of 0 to 7. When the desired program number is adjusted, you can exit the 'Cam programming' mode by pressing the  key.

### 6.5.2. Selecting an output

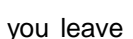
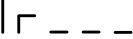



If you press the  key during program selection, you enter the mode of the cam programming. The display shows e.g. . This indicates that no cam has been programmed on output 1 in the 'Output selection' mode. By pressing the  key or the  key you can now select the output on which you want to program cams.



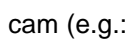

### 6.5.3. Shifting the activation point

By pressing the  key you leave the 'Output selection' mode  and enter the 'Activation point' mode . A pressing of the  key or the  key shifts the activation point by one step. This is done according to the following system:

A short single pressing of the  key will erase the activation point at the previously displayed preset value, e.g. 100, and then the preset value is increased by 1, e.g. to 101. A short pressing of the  key will lower the preset value (100 in our example) by 1 and then set a new activation point at e.g. 99.

### 6.5.4. Shifting the deactivation point

Pressing the  key once more leads you from the 'Activation point' mode  into the 'Deactivation point' mode . CamCon will first search for the deactivation point of the current cam (e.g.: ). By pressing the  or the  key the deactivation point is shifted by one step. This is done according to the following system:

A single short pressing of the  key will set a new switching point at the previously displayed preset value, e.g. 100. Then the preset value is increased by one, e.g. to 101. A short pressing of the  key will lower the preset value, e.g. 100, by 1 and then delete the switching point 99. The new deactivation point is then 99. A further pressing of the  key brings you back to the 'Output selection' mode .

### 6.5.5. Leaving cam programming

No matter in which programming mode you are, you can always leave cam programming by pressing the **F** key. The standard display appears **0000**.

### 6.5.6. Examples for cam programming in the programming mode "1"

#### 6.5.6.1. Cam programming

##### Task:

After a complete deletion of the program memory and a successful initialization of the system, a cam shall be programmed in program 0 for output 2 from 100 to 200.

##### Solution:

1. Press the **↵** key (for about 2 sec.), until you enter the 'Program selection' mode: **P A 0**.
2. Press the **↵** key (for about 2 sec.), you enter the 'Output selection' mode **0 2 \_ \_ \_**.
3. Press the **+** key to select output 2, **0 2 \_ \_ \_**.
4. Press the **↵** key for the programming of the activation point **0 2 1 \_ \_**.
5. Press the **+** key and keep it pressed until **0 2 1 0 0** is displayed.
6. If you released the **+** key too early or too late, you can adjust the preselection to 100 with the **-** or the **+** key.
7. Press the **↵** key to program the deactivation point.
8. Press the **+** key and keep it pressed until the display shows **0 2 2 0 0**.
9. If you have released the **+** key too early or too late, you can adjust the deactivation point to 200 with the **-** or the **+** key.
10. Press the **F** key. You return to the standard display.

#### 6.5.6.2. Deletion of cams

##### Task:

You want to delete the cam 100 to 200 on output 2 in program 0.

##### Solution:

1. Press the **↵** key (for about 2 sec.), until you enter the 'Program selection' mode: **P A 0**.
2. Press the **↵** key (for about 2 sec.), you enter the 'Output selection' mode **0 2 \_ \_ \_**.
3. Press the **+** key to select output 2, **0 2 1 0 0**. The start of the found cam is displayed.
4. Press the **↵** key to program the activation point. The display shows **0 2 1 0 0**.
5. Press the **+** key and keep it pressed until **0 2 2 0 0** is displayed.
6. If you released the **+** key too early, shift the deactivation point to 200 by repeatedly pressing the **+** key. If you released the **+** key too late, do not correct it ! The cam is then already erased. Shifting the activation point backwards programs a new cam in consequence. This cam should be deleted.
7. Press the **F** key. You return to the standard display.

## 7. Outline of operations

### 7.1. Switching the standard display

Press the <b>+</b> key shortly		Display of program and speed display (min <sup>-1</sup> )
Press the <b>-</b> key shortly		Position display
Press the <b>-</b> key shortly		Display of program and speed display (min <sup>-1</sup> )

### 7.2. Programming the system constants

Press the <b>-</b> key shortly		Display of program and speed display (min <sup>-1</sup> )
Press the <b>-</b> key shortly		User key for system constants
Press the <b>-</b> key shortly		User key for system constants
Press the <b>-</b> key shortly		User key for system constants
Press the <b>-</b> key shortly		User key for system constants
Press the <b>+</b> key shortly		User key for system constants
Press the <b>+</b> key shortly		User key for system constants
Press the <b>+</b> key shortly		User key for system constants
Press the <b>+</b> key shortly		User key for system constants
Press the <b>F</b> key about 2 sec.		Encoder resolution
Press the <b>F</b> key shortly		Encoder F/R switching
Press the <b>F</b> key shortly		Zero point correction
Press the <b>F</b> key shortly		Cam programming mode
Press the <b>F</b> key shortly		Display of program and speed display (min <sup>-1</sup> )

### 7.3. Dead time programming

Press the <b>F</b> key about 2 sec.		Display of program and speed display (min <sup>-1</sup> )
Press the <b>F</b> key shortly		Dead time compensation for Output 1
...		Go to Output 2
Press the  key shortly		Display of program and speed display (min <sup>-1</sup> ) You return to the standard display.

### 7.4. Cam programming

Press the  key about 2 sec.		Display of program and speed (min <sup>-1</sup> ) Program selection
Press the  key shortly		Selecting an output
Press the  key shortly		Searching for cam activation point (only in mode "0")
Press the  key shortly		Enter position of preselection (only in mode "0")
Press the  key shortly		Shifting the activation point
Press the  key shortly		Searching for and shifting the deactivation point
Press the  key shortly		Selecting an output
Press the <b>+</b> key shortly		Selecting the next output
Press the <b>F</b> key shortly		Display of program and speed display (min <sup>-1</sup> )

## 8. watch doc

The CamCon deactivates all output within 1ms when an error occurs. This behavior can be used as an extreme error message. Program a cam over the whole range of a chosen output (0 to 360 degrees) (security cam). This output should be slaved into the emergency deactivation circuit. To be able to program a security cam over the whole range.

After the security cam has been programmed, the display shows e.g.:  $\square \square \cdot \cdot \cdot \cdot$ .

## 9. Troubleshooting

### Problem:

The display remains dark after activation.

### Solution:

The wiring is probably not correct. Check the wiring.

### Problem:

The display shows:  $I - E \Gamma \Gamma$ .

### Solution:

Either the encoder is connected incorrectly or not at all, or the encoder resolution of the connected encoder does not coincide with the input encoder resolution. Check the wiring to the encoder or the input of the encoder resolution. When the error is corrected, press any key to clear the error message of the display.

### Problem:

The display shows:  $A - E \Gamma \Gamma$ .

### Solution:

Your outputs are overloaded or have short circuited. Check the wiring and the connected power as well as any inductive loads, that are operated without a free wheel or a deletion unit. An output can supply up to 500mA of current. When the error is corrected, press any key to clear the error message of the display.



### **Caution:**

*Infavourable cable routing can lead to the deactivation of the outputs, since it builds up a potential that is redirected into the outputs at the closing of a contact. With induced loads the outputs have to be switched with a freewheeling diode. Covers or inductivities very close to the device inside the switchboard have to be switched with a deletion unit as do those that are wired to or influence the wiring of the device.*

## 10. Technical data of the CamCon

Multifunctional display for programming .....	7-segment, 5-digits, 13mm
Number of outputs .....	16
State display of the outputs.....	a red LED each
Number of programable cams .....	500
Number of programs.....	8
Cycle time, (switching speed) .....	1ms
Dead time compensation (DTC) .....	for each output
Range of the DTC.....	0 to 255ms
Exactness of the DTC.....	+0 to -1 step
Encoder input.....	synchronous serial (SSI), gray coded
Encoder type.....	AAG60007
Encoder resolution.....	360 steps / rotation
Zero point correction .....	electronical adjustment inside CamCon
Rotatory direction of the encoder.....	is programmed by CamCon
Length of the connecting cable between encoder and CamCon .....	200m
Data security/memory .....	EEPROM
Supply voltage.....	24V DC $\pm$ 20%
Encoder supply voltage.....	with 24V DC over supply voltage of CamCon
Current reception .....	200mA without encoder and outputs
Output current.....	500mA, short circuit proof permanent current (see 4.3. The outputs)
Output voltage.....	24V DC, pluse switching

### Connections for:

Encoder.....	through plug block clips
Voltage supply.....	through plug block clips
Cam outputs .....	through plug block clips
Operating temperature.....	0°C to +55°C
Cover type for:	
Front plate / full sight gate.....	IP 67 / IP 55
Cabinet.....	IP 40
Dimensions .....	see fig. on page 10
Front plate part.....	138 x 138mm + 1
Cabinet (switch plate cabinet by DIN 43700).....	144 x 144 x 63mm (WxHxD)
Cover of the front plate .....	Full sight gate, can be locked with security key
PC - connection .....	with PC30 Software package
Weight.....	about 600g

## 11. Keyword table

Activation point, Shifting.....	16; 21
Cable covers.....	10
Cam programming.....	16; 21; 23
Cam programming, Examples.....	18; 22
CE.....	2
Commissioning.....	14
Connections, electrical.....	11
Deactivation point, Shifting.....	17; 21
Dead time compensation.....	15
Dead time programming.....	23
Delay time compensation, Effects.....	7
Delay time, Calculation.....	9
Deletion of cams.....	22
Deletion, Complete.....	14
Dimensions.....	10
Display of position and speed.....	13
Encoder.....	12
Encoder resolution.....	15
F/R change over.....	15
Grounding pins.....	10
Initialization.....	14
Installation.....	10
Installation procedures.....	10
Keyboard.....	13
Keyboard lock, external activation.....	12
Leaving cam programming.....	17
millenium.....	2
Operation, Outline.....	23
Operator terminal, Outline.....	13
Output display.....	13
Output selection.....	16
Output, Selection.....	21
Outputs.....	12
PDF - File.....	2
Pin allocation.....	11
Precautions.....	12
Preset value, Setting.....	16
Program selection.....	16; 21
Program selection, external.....	12
Programming mode, Setting.....	15
Searching for cams.....	16
Speed Compensation, Effects.....	7
Standard display, Switching.....	23
System constants, Programming.....	23

Table of contents .....	3
Technical data.....	25
Troubleshooting .....	24
Update .....	2
User keys .....	14
watch doc.....	24
Y2K .....	2
Zero point correction .....	15