

Digital Cam Switch Unit

CamCon DC50/51



Digitronic Automationsanlagen GmbH

Auf der Langwies 1 · D - 65510 Hünstetten-Wallbach · Tel. +49 6126 9453-0 · Fax -42
Internet: <http://www.digitronic.com> · E-Mail: mail@digitronic.com

For your attention

This instruction manual relates to the CamCon DC50/51 from 2009/03/23. The company Digitronic Automationsanlagen GmbH reserves the right to make changes which present an improvement of the quality or functionality of the device without prior notice. The instruction manual was created with great care, although it may not be error-proof. We would be grateful for any communication relating to any errors you may have found.

Update

You can also obtain this instruction manual on the Internet at <http://www.digitronic.com> in the latest version as PDF file.

Qualified personnel

This device may only be started and operated by qualified staff. By qualified we mean personnel who are entitled to handle, to earth and to label devices, systems and power circuits in accordance with the technology safety standards.

Liability

(1) The supplier is liable for damages caused by himself or by the owner of the rights up to the sum of the sales price. He is not liable for loss of profits, forfeited savings, intermediate and successive damages.

(2) The above mentioned limits to liability do not apply to insurance of named characteristics and damages which were caused deliberately or through negligence.

Protection

The CamCon DC50/51 and this instruction manual are protected by copyright. All rights are reserved. Neither the CamCon DC50/51, nor this document may be copied as a whole or partially, photocopied, reproduced, translated or transferred to electronic media of any kind or into machine readable format without prior written permission by the company Digitronic Automationsanlagen GmbH.

Note: CamCon is a registered trademark of the company Firma Digitronic Automationsanlagen GmbH.

Note: The devices of the CamCon series comply with norms: DIN EN 61000-6-2, DIN EN 61000-4-2, DIN EN 61000-4-4, DIN EN 61000-4-5, DIN EN 61000-4-8 and DIN EN 55011 and RoHS 2 (2011/65/EU)..



(c) Copyright 1992 - 2017 / File: DC50E.DOC

Digitronic Automationsanlagen GmbH
Auf der Langwies 1
D-65510 Hünstetten - Wallbach
Tel. (+49)6126/9453-0 Fax. (+49)6126/9453-42
Internet: <http://www.digitronic.com>
E-Mail: mail@digitronic.com

TABLE OF CONTENTS

1. Introduction	7
2. Operating Principles	8
2.1. Speed Compensation	9
2.1.1. Measuring delay time for Speed Compensation	11
2.1.1.1. Measuring delay time through actual differences	11
2.1.1.2. Measuring delay time by means of different measuring points	11
2.1.2. Speed Compensation using off-centre pressure, e.g. brake functions	12
2.1.3. Not linear Speed Compensation (NLT)	13
2.1.4. Separate delay time for Speed Compensation of switch-ON and switch-OFF points	13
2.2. Time - Cam	13
3. Installation	14
3.1. Dimensions	14
4. Electrical connections	15
4.1. Pin allocation of the CamCon	15
4.1.1. Pin allocation if two analog outputs (option)	15
4.1.2. Pin allocation if one analog input and one analog output (option)	15
4.1.3. Pin allocation of the SSI measuring system	16
4.1.4. Pin allocation of the incremental measuring system	16
4.1.5. Pin allocation of the inputs	16
4.1.6. Pin allocation of the outputs	17
4.1.7. Pin allocation of the voltage supply	17
4.1.8. Pin allocation of the serial interface	18
4.1.8.1. Pin allocation of the serial RS232 interface	18
4.1.8.2. Pin allocation of the serial RS485 interface	19
4.1.9. Pin allocation of the external interface	20
4.2. The measuring system	21
4.2.1. SSI Measuring system input	21
4.2.2. Parallel measuring system input	21
4.2.3. Incremental measuring system input	22
4.2.3.1. Incremental measuring system input with 5V RS422 level	22
4.2.3.2. Incremental measuring system input with 24V PNP level	22
4.2.3.3. Incremental Hipurface measuring system input with SINCOS level	23
4.2.4. Analog measuring system input	23
4.2.5. PLL measuring system input	24
4.2.6. Timer as a measuring system	24
4.2.7. RS232 as a measuring system	24
4.3. The outputs	25
4.3.1. The 40mA outputs (only CamCon device with aluminium back wall)	25
4.3.2. The 500mA outputs	25
4.4. The inputs	25
4.5. Precautionary measures for welding work	25
5. Outline of the operator terminal	26
5.1. Frontview CamCon	26
5.2. The liquid crystal display (LCD)	26
5.3. Contrast setting	26
5.4. The keyboard	26
5.5. Outline of key functions	27
5.6. Menu selection	27
5.7. Selection of a menu point	27
5.8. Text input	28

6. Commissioning	29
7. Operation of the CamCon	31
7.1. The main menu	31
7.2. The standard display	31
7.2.1. Changing the display	31
7.2.2. Program change	32
7.2.3. Program name	32
7.3. Cam programming	33
7.3.1. Output selection for programming	33
7.3.2. Program selection for programming	34
7.3.3. Programming the delay time/speed compensation	34
7.3.4. Programming a Not - Linear - Speed compensation (NLT)	35
7.3.5. Programming Time-Cams	35
7.3.6. Programming the output name	36
7.3.7. Cam Input	36
7.3.8. Adding cams	37
7.3.9. Cam Teach - In	37
7.3.10. Cam Search	37
7.3.11. Cam deletion	38
7.3.12. Output (cam track) deletion	38
7.3.13. Copying programmed outputs (cam tracks)	39
7.3.14. Shifting cam tracks	39
7.3.15. Deleting programs	40
7.3.16. Copying programs	40
7.3.17. Examples for cam programming	41
7.3.17.1. First cam programming	41
7.3.17.2. Programming additional cams on an output	42
7.3.17.3. Deletion of a particular cam	43
7.3.18. Programming analog cams	44
7.3.18.1. Creating the first analog cam	45
7.3.18.2. Adding an analog cam	45
7.3.18.3. Changing the analog cam	45
7.4. Unit configuration (system setting)	46
7.4.1. Measuring system	46
7.4.1.1. The standard measuring systems	46
7.4.1.2. The actual position hysteresis	46
7.4.1.3. Controlling the measuring system	47
7.4.1.4. The electronic gear	48
7.4.1.4.1. Electronically changing the rotation direction	48
7.4.1.5. The display format of the actual position	48
7.4.1.6. Configuration of a special measuring system	49
7.4.1.6.1. SSI - measuring system	49
7.4.1.6.2. Parallel - Gray measuring system	50
7.4.1.6.3. Incremental - measuring system	50
7.4.1.6.4. Multiturn measuring system with electronic gear	51
7.4.1.6.5. PLL measuring system	52
7.4.1.6.6. Timer way simulation (time emitter)	52
7.4.1.6.7. RS232 measuring system	53
7.4.1.6.8. AG615 - Single - Multiturn - Measuring system	53
7.4.1.6.9. SIM - measuring system simulator	54
7.4.1.6.10. HIPER i.e. incremental - measuring system with Roll - Over - funktion	54
7.4.1.7. Deleting the special measuring system	55
7.4.2. The measuring offset	56
7.4.2.1. Zero offset with rotatory movements	56
7.4.2.2. Measuring offset with a linear moved system	56
7.4.2.3. Zero offset with linear movements	56

7.4.2.4. Actual position preset.....	57
7.4.3. The speed adjustment	58
7.4.3.1. The speed factor	58
7.4.3.2. The display format of the speed display.....	58
7.4.3.3. Range adjustment of the speed display.....	58
7.4.3.4. Accuracy of the speed display	59
7.4.3.5. Display, Type.....	59
7.4.4. Cable length / Cycle time	60
7.4.4.1. The cable length.....	60
7.4.4.2. The cycle time of the CamCon.....	60
7.4.5. The special outputs	61
7.4.5.1. The digital special outputs.....	61
7.4.5.2. The security output.....	61
7.4.5.2.1. The output of the actual position	61
7.4.5.2.2. Direction output	62
7.4.5.2.3. The standstill output (Move output).....	62
7.4.5.2.4. The hysteresis.....	62
7.4.5.2.5. The Move hysteresis of the standstill output.....	62
7.4.5.3. The analog special outputs	63
7.4.5.3.1. The analog speed output	63
7.4.5.3.2. Configuration of the analog cams	63
7.4.5.4. The analog position output.....	65
7.4.6. System upgrading	65
7.4.6.1. Setting the inputs	65
7.4.6.2. Setting the outputs	65
7.4.6.3. Setting the outputs with speed compensation	65
7.4.6.4. Setting the Not - Linear - Speed compensation(NLT).....	65
7.4.6.5. Setting the keyboard lock.....	65
7.4.6.6. Error - acknowledging Input (EQ)	65
7.4.6.7. Input for enableing Outputs	65
7.4.6.8. Setting the external program selection	66
7.4.6.9. Setting the program selection mode	66
7.4.7. Masterprogram.....	67
7.5. Unit configuration	68
7.5.1. User key allocation.....	68
7.5.1.1. Creating a new user key	68
7.5.1.2. Deletion of a user key	69
7.5.1.3. Checking the key configuration.....	69
7.5.2. Complete deletion	70
7.5.3. Unit configuration	71
7.5.3.1. Setting the serial interface.....	71
7.5.3.1.1. The "Cam-BUS" communication mode.....	71
7.5.3.1.2. The "Standard" communication mode	71
7.5.3.1.3. The "Multiuser" communication mode	71
7.5.3.1.4. The "S5 - L1" communication mode	71
7.5.3.1.5. The "3964(R)" communication mode.....	71
7.5.3.1.6. Input of the unit number	72
7.5.3.1.7. Programming via remote.....	72
7.5.3.2. Additional device options	72

7.5.3.2.1. PLC Logic Module.....	72
7.5.3.2.1.1. Examples for using the PLC logic module	72
7.5.3.2.2. PLC Logic Module with text display.....	73
7.5.3.3. Analog outputs	74
7.5.3.3.1. Clearing the integrated analog outputs	74
7.5.3.3.2. Adjusting the integrated analog outputs.....	74
7.5.3.3.3. External analog outputs	74
7.5.3.4. Locking EEPROM memory	75
7.5.4. Language	76
7.5.5. Configure user	76
7.5.5.1. User text.....	76
7.5.5.2. User-Menu/OP-functions	77
7.5.6. Configure Hardware.....	77
7.5.6.1. Simple Hardware Configure.....	77
7.5.6.2. Enhanced Hardware Configure (I/O - Routing).....	77
7.5.6.3. CP16 Module	78
8. Device info	79
8.1. Stack Info.....	81
9. Error messages and removal of errors (FAQ)	82
9.1 Problem: Display shows "No contact to unit: XX".	82
9.2. Problem: "Pos - Err:1" respectively error number 1.....	82
9.3. Problem: "Pos - Err:2" respectively error number 2.....	82
9.4. Problem: "Pos - Err:3" respectively error number 3.....	83
9.5. Problem: "Pos - Err:5" respectively error number 5.....	83
9.6. Problem: An "Pos-Error:" occurs during operation.....	83
9.7. Problem: "RAM-Full" = RAM memory is full.....	83
9.8. Problem: The EEPROM memory is full.....	84
9.9. Problem: Outputs will not activate.....	84
9.10. Problem: "Out - Error" respectively error number 4.	84
9.11. Problem: Error in the EEPROM respectively error number 255.	84
9.12. Problem: "Error ???".	84
9.13. Problem: "Clear....".	85
10. Menu outline.....	86
11. Calculation EEPROM cam storage.....	87
12. Calculation the RAM storage-requirement for CamCon	88
13. Technical data of the CamCon	89
14. Key word table.....	90

1. Introduction

Electronic Cam Switch Units have been successfully used in industry for a long time. Experiences collected in close liaison with users over the years have been included in the development of the CamCon series. The result is a compact digital cam switch unit which is user friendly and reliable to a high degree. The following characteristics testify the excellence of the CamCon:

- * Tested and reliable hardware
- * Short-circuit-proof outputs
- * Graphic liquid crystal display with 128x64 pixels in the CamCon DC50,51.
- * Large and clearly visible 7-Segment display for program, position and speed on CamCon DC30,33 and 40.
- * Any number of cams per output can be programmed.
- * Up to 32000 Programs for product administration
- * Master, for example: machine cams
- * Optimising switch points when machine is in operation
- * Compensation of mechanical delay time of switch components for switch-ON and switch-OFF points can be set in steps of 100µs separately (DTC = delay time or Speed Compensation).
- * Not linear Speed Compensation (NLT).
- * Position - Triggert - Time - Cams
- * Power supply 24V DC +/- 20%
- * Mounting of suspension rails to EN 50022 on CamCon DC16 and 90
- * Switchboard panel standard casing 144 x 144 x 63mm to DIN 43700 on CamCon DC33,40 and 51
- * S5 Components group for S5 115U, 135U and 155U on CamCon DC115
- * S7 Components group for S7 300 on CamCon DC300
- * AB Components group for ControlLogix[®] 1756 on CamCon 1756-DICAM
- * S5 Switch-ON via PG interface with L1 - Bus on CamCon DC16,40,50,51 and 90
- * PLC Logic Module (optional)
- * Shift register (optional)
- * OP - Functions
- * Analog outputs (optional)

Cam switch units are used wherever switching operations are periodically repeated. Digital cam switch units are an optimum replacement of mechanical units and offer in addition many other advantages, such as:

- * Simplification of mounting and adjustment operations
- * Repeatable adjustment facility
- * Standardised for almost all areas of application
- * Reliability
- * High switch speed
- * Speed Compensation
- * Product administration for quick format change

2. Operating Principles

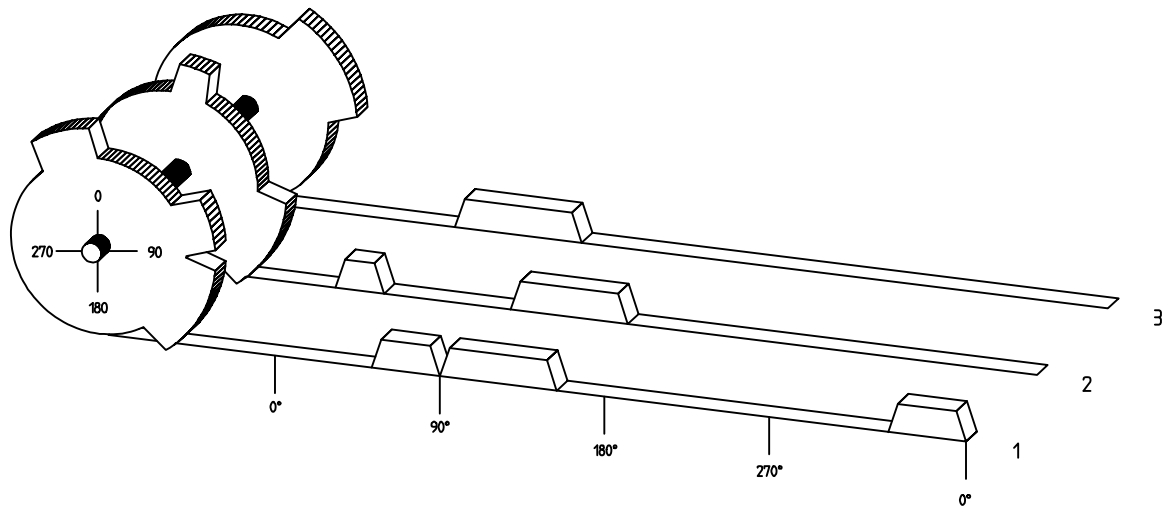

Diagram: Principles of a Cam Switch Unit

A principle for better comprehension of the function of a Cam Switch Unit is here presented. It has 3 outputs with the following cams:

Output 1:	Cam 1:	Switch-ON position	60°	Switch-OFF position	85°
	Cam 2:	Switch-ON position	95°	Switch-OFF position	145°
	Cam 3:	Switch-ON position	325°	Switch-OFF position	355°
Output 2:	Cam 1:	Switch-ON position	5°	Switch-OFF position	20°
	Cam 2:	Switch-ON position	95°	Switch-OFF position	145°
Output 3:	Cam 1:	Switch-ON position	30°	Switch-OFF position	85°

The positions of the output signals, here presented as three tracks, occur when the three cam disks turn anti-clockwise past a sensor, which scans the cams on the 0°-axis.

In a mechanical cam switch unit, the switch interval, i.e. the range between switch-ON and switch-OFF position are determined by the length of the cam. The length and the position of the cam can only be varied marginally and this is mechanically highly demanding and time consuming. With CamCon such adjustments can be realised in a fraction of time; in addition, there can be any number of tracks. A measuring system which is fitted to the device reports the position to the CamCon. The CamCon compares it with the programmed switch-ON and Switch-OFF positions of all outputs. If the position lies in the range of a programmed switch-ON / switch-OFF position (cam), then the respective outputs are active.

2.1. Speed Compensation

Each mechanical switch component (e.g. shield, magnetic valve) has a delay time, i.e. the time between the start signal and the actual switching of the contacts. In processes where positioning is executed on a moving system, this can cause problems. If such a process is driven with different speeds, different positions are caused. To avoid this happening, new timings for the switch signals of each speed would have to be calculated.

In order to illustrate the complicated issues surrounding delay time or speed compensation, this will be shown on the example of a packaging machine. In the process shown in the diagram, a glue point has to be placed in an exactly defined spot on a moving paper track.

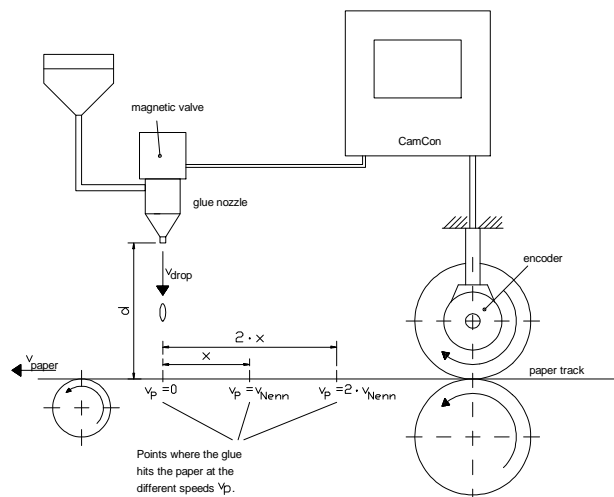

The system has the following parameters:

- v_p - Speed of the paper track
- v_T - Falling speed of the drop of glue
- d - Distance between the glue nozzle and the paper track
- T_{MV} - Delay time of the magnetic valve

Without speed compensation the following would happen:

As soon as the measuring system has reached a certain position, the CamCon sends a signal to the magnetic valve. The glue nozzle opens for a short time during which a drop of glue ejects. Between the start of the impulse and the exit of the drop time passes, which is mainly caused by the delay time of the magnetic valve T_{MV} . A further delay is caused by the time which the droplet needs to pass the distance between the glue nozzle and the surface of the paper.

This flight time is calculated as follows:

$$t_{\text{Flight}} = \frac{d}{v_T}$$

In total there the delay time is $t_{\text{Flight}} + T_{MV}$. During this time the paper track moves on by a specific distance x .

It would now be possible to move the position, where the magnetic valve is switched on, forward by a specific amount, so that the glue droplet hits the same spot again as during standstill. In this way a speed compensation is created which works only at a specific speed of the paper. As soon as the speed of the device and consequently that of the paper track is, for example, doubled, the hit point of the glue droplet is shifted by the distance x , so that, without any speed compensation, it would move backward by double the distance ($2 \cdot x$) in total.

The automatic speed compensation of the CamCon makes it now possible to drive processes with variable speed; CamCon registers the speed of the device continuously and adjusts the cams which determine the switch time points "On Line" depending on the speed. This has the effect that the outputs for the switch components are switched ON or OFF earlier. The direction of the movement is of no significance in this instance.

A small example in figures was designed to elucidate:

Supposing the drive cylinder with the measuring system has a circumference of 360mm, so that one millimeter of the circumference corresponds to exactly one angle degree of the measuring system.

The device has the following parameters:

$$\begin{aligned}v_{\text{droplet}} &= 20\text{m/s} \\d &= 20\text{cm} \\T_{\text{MV}} &= 20\text{ms}\end{aligned}$$

This results in the following flight time of the droplet:

$$t_{\text{Flight}} = \frac{d}{v_T} = \frac{0,2\text{m}}{20\text{m/s}} = 10\text{ms}$$

The total delay time is then $T_{\text{dead, altogether}} = T_{\text{MV}} + t_{\text{Flight}} = 20\text{ms} + 10\text{ms} = 30\text{ms}$

During this time the paper track moves on by the distance $x = v_{\text{paper}} \cdot T_{\text{total delay}} = 1\text{m/s} \cdot 30\text{ms} = 30\text{mm}$. In order to compensate the delay time, the switch point for the magnetic valve must be moved forward by 30°.

If the speed of the device and consequently that of the paper is doubled v_{paper} , then the distance x is also doubled by the speed of the paper track. In this case the switch point must be moved by 60°.

Note: Please take into account in these explanations that delay time is of a fixed size, which is determined by the mechanical constants of the set and switch components and by the dimensions of the construction and therefore does not change!

If the total delay time of 30ms was programmed into the respective output of CamCon, then the glue droplet would always hit the right spot, regardless of the speed.

2.1.1. Measuring delay time for Speed Compensation

Several ways of measuring delay time of a relay or valve are available.

2.1.1.1. Measuring delay time through actual differences

First the switch-ON point of a valve or relay is programmed. We assume that the programmed switch point lies at 200 degrees in this case. If the machine is driven with a speed of for example 40 rpm, a shift occurs due to delay time. This shift is then measured and, in this example, will amount to 40 degrees.

Warning: For the calculation of the shift the programmed delay time in the cam switch unit must be set to zero!

The delay time of the switch component is now calculated as follows:

$$\text{Delay time (in sec.)} = \frac{\Delta \text{ way (in } ^\circ \text{)} * 60 \text{ (sec./min.)}}{\text{speed (in rpm)} * 360 \text{ (} ^\circ\text{/turn)}}$$

$$\text{Delay time (in sec.)} = \frac{40 * 60}{40 * 360} = 0.1667 \text{ sec.}$$

The resultant delay time is then entered into the cam switch unit.

See Chapter "7.3.3. Programming the delay time" an page 34.

2.1.1.2. Measuring delay time by means of different measuring points

First the switch point is calculated at a speed of, for example, 50 rpm. We assume that the programmed switch point lies at 200° in this case. The second measurement is taken at a speed of 80 rpm. The necessary switch point must be set to 160°, if the exact switch point is to be also achieved at 80 rpm.

Warning: For the calculation of the two switch points the programmed delay time in the cam switch unit must be set to zero!

The delay time of the switch component is then calculated with the following formula:

$$\text{Delay time (in sec.)} = \frac{\Delta \text{ way (in } ^\circ \text{)} * 60 \text{ (sec./min.)}}{\Delta \text{ speed (in rpm)} * 360 \text{ (} ^\circ\text{/turn)}}$$

$$\text{Delay time (in sec.)} = \frac{40 * 60}{30 * 360} = 0.222 \text{ sec.}$$

The resultant delay time is then entered into the cam switch unit.

See Chapter "7.3.3. Programming the delay time" an page 34.

Since the entered delay time shifts the switch point, the previously programmed cam must be changed. For the calculation of the exact switch-ON position, the difference to the speed 0 rpm (here using 50 rpm) must be added to the first measured switch-ON point (here 200°). The difference is calculated with the following formula:

$$\Delta \text{ way (in degrees)} = \frac{\text{dead time (in sec.)} * \Delta \text{ time (in min}^{-1}\text{)} * 360 \text{ (degrees/rotations)}}{60 \text{ (sec./min.)}}$$

$$\Delta \text{ way (in degrees)} = \frac{0.222 * 50 * 360}{60} = 66.6 \text{ degrees}$$

The switch-ON point of the cam is now shifted from 200° by approx. 67° to 267°.

2.1.2. Speed Compensation using off-centre pressure, e.g. brake functions

The Speed Compensation of the CamCon Cam switch unit works using a linear function. If, for example, the speed doubles, then the shift of the compensated cam changes and also moves forward by twice the amount. If the ram on an eccentric press should be brought to a standstill at the exact upper stop point, the brake action of the press under different speeds results in a quadratic function. The Speed Compensation can therefore only find an approximation of the exact switch point for the stopping of the press by adjusting the line of the cam lines to the brake curves in the working range of the press.

Note: See also the next chapter "2.1.3. Not linear Speed Compensation (NLT)".

In the graphic on the right the curved line represents the brake point of the ram in relation to the speed.

For the calculation of the parameters to be programmed please proceed as follows:

- Define the working range (e.g. 20-50 rpm) and determine two measuring points which have to be specified in the working process (e.g. 30 and 40 rpm).
- Now let the machine run at 30 rpm and program or optimise a cam **without** Speed Compensation so that, at switch-OFF, the ram comes to a halt in top stop. Note the switch-ON point of the cam (e.g. 340°).
- Now let the machining work with 40 rpm and program or optimise one cam **without** Speed Compensation so that, at switch-OFF, the ram comes to a halt in top stop. Once again, note the switch-On point of the cam. (e.g. 332°).
- Now calculate the delay time, taking into account the distance and speed difference, using this formula:

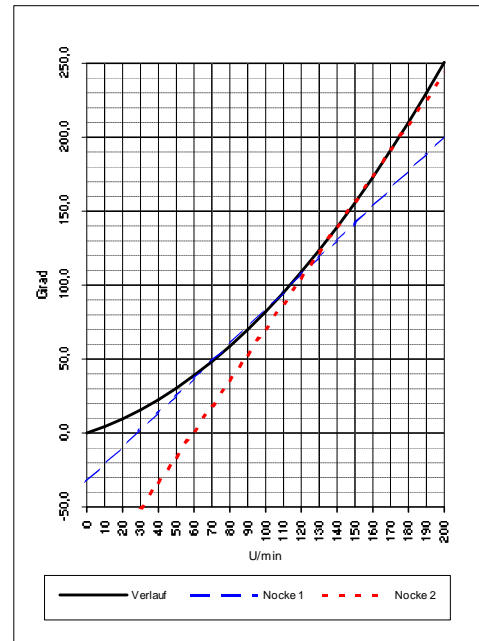

$$\text{Delay time (in sec.)} = \frac{\Delta \text{ way (in } ^\circ) * 60 \text{ (sec./min.)}}{\Delta \text{ Speed (in rpm.)} * 360 \text{ (}^\circ\text{/turn)}} = \frac{340-332 * 60}{40-30 * 360} = 0.133 \text{ sec.}$$

- The calculated delay time is now entered into the cam switch unit.
- Since the switch-OFF point has shifted through the entered Speed Compensation, the previously programmed cam must be changed first. For the calculation of the exact switch-ON position, the difference to the speed 0 rpm (here 30 rpm) must be added to the first measured switch-ON point (first measuring point here 340°) The difference is calculated with the following formula:

$$\Delta \text{ way (in } ^\circ) = \frac{\text{delay time (in sec.)} * \Delta \text{ Speed (in rpm.)} * 360 \text{ (}^\circ\text{/turn)}}{60 \text{ (sec./min.)}} = \frac{0.133 * 30 * 360}{60} = 23.94^\circ$$

- The switch-ON point of the cam has now shifted from 340° by approx. 24° to 364°.

As a result a cam with a switch-ON point of 4° and a speed compensation of 0.133 sec has been calculated. This is entered in the cam switch unit as switch-OFF cam of the press.

Note: If the degree of accuracy is no longer sufficient when switch-OFF is done with one cam, two or several outputs can be switched in parallel and the cam of those is then adjusted to the required working range. For the calculation of two switch-OFF cams divide the working range in 5 parts with 4 measuring points and then calculate the delay time value and the cam value with the same formula as described above. For the calculation of the first cam, use the measuring points 1 + 2 and for the calculation of the second cam use the measuring point 3 + 4.

Through this association of the linear cam functions to the brake functions it is now possible to switch OFF the cam via the entire working range of the press in the top stop.

2.1.3. Not linear Speed Compensation (NLT)

The method for the compensation of a not linear Speed Compensation, descriptive in the chapter before can with devices with a software starting from 11/2004 by the non linear Speed Compensation (NLT) simplified be entered. You need only one cam or a shift register output of the SPS - logic - becomes module with NLT - speed compensation.

For this you have to define in the CamCon a table with speed compensation - and velocity values.

To the right you see a characteristic curve with 5 base points.

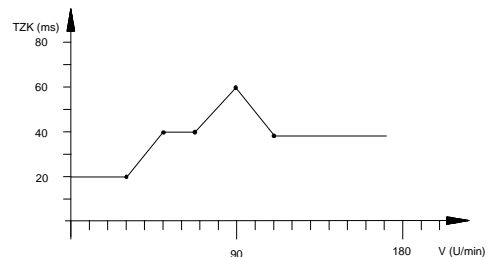

2.1.4. Separate delay time for Speed Compensation of switch-ON and switch-OFF points

For CamCon devices of Software from 3/2002 Speed Compensation is now available for separate switch-ON and switch-OFF points. This is necessary since some valves need longer to switch OFF than to switch ON.

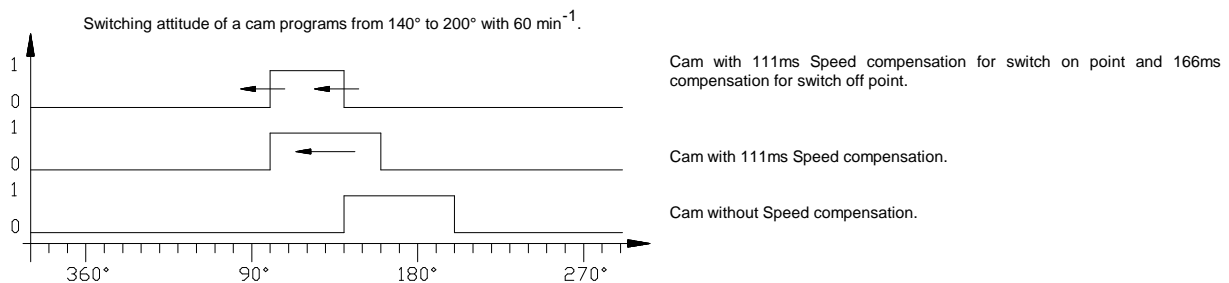

For the calculation of both delay times the same formulæ are used as for a *normal* compensation. See Chapter "2.1.1. Measuring delay time for Speed Compensation" on page 11 for entering delay time see Chapter "7.3.3. Programming the delay time" on page 34.

Attention: If the switch-off-point of a Cam overtakes the switch on point at rising speed, the result will be an non-defined signal.

2.2. Time - Cam

With normale cam becomes with increasing plant speed switch-on time ever more briefly. If controlling a glueing-station, the result would be an insufficient amount of spreaded glue.

A Time - cam however has with each plant speed a firm temporal length, so that exactly the same amount of glue could be spread at changing speeds. The switch-on point of the Cam on a *normal* as well as on a Time-Cam is appointed by a position-dependent Position value and a delay-time/speed compensation.

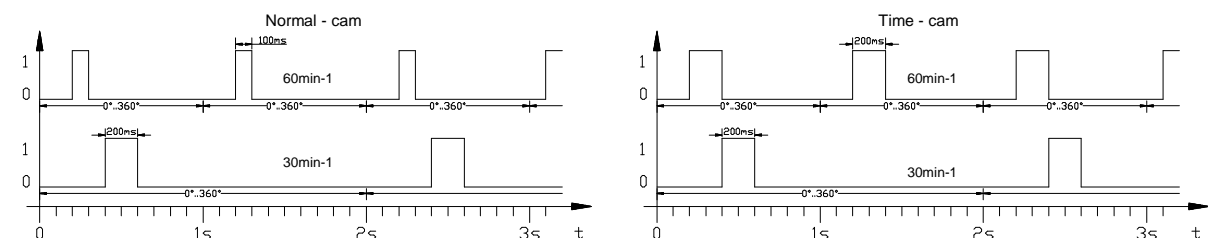

For CamCon devices of software releases after 3/2002 Time Cam is also available for devices without PLC - Logic - Module.

For entering a Time - Cam see Chapter "7.3.5. Programming Time-Cams" on page 35.

3. Installation

The unit is inserted into a cutout for front plate installation (see chapter "3.1. Dimensions" on page 14). Connect the ground pins on the back of the encasement as well as the cable cover to a grounding point of the switchboard door in the shortest possible way. All cable connections must be done in a cold state! The connection cables, e.g. for the measuring system or the serial interface, must be wired with covers, and the covers have to be grounded on both ends. Analog signals must also be wired with covers, and the covers have to be grounded on one end.

3.1. Dimensions

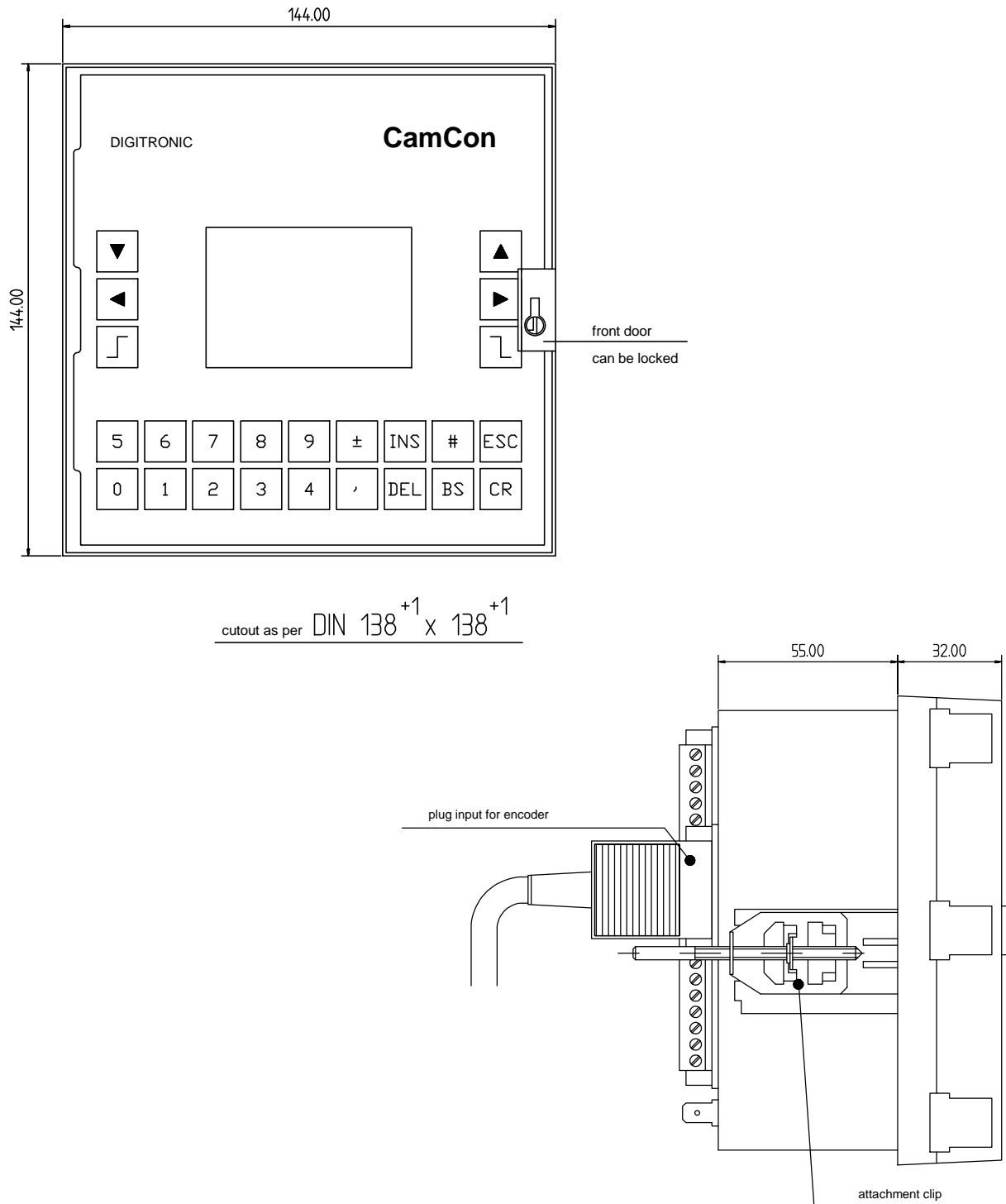

Fig.: Drawing to aid the installation of CamCon

4. Electrical connections

4.1. Pin allocation of the CamCon

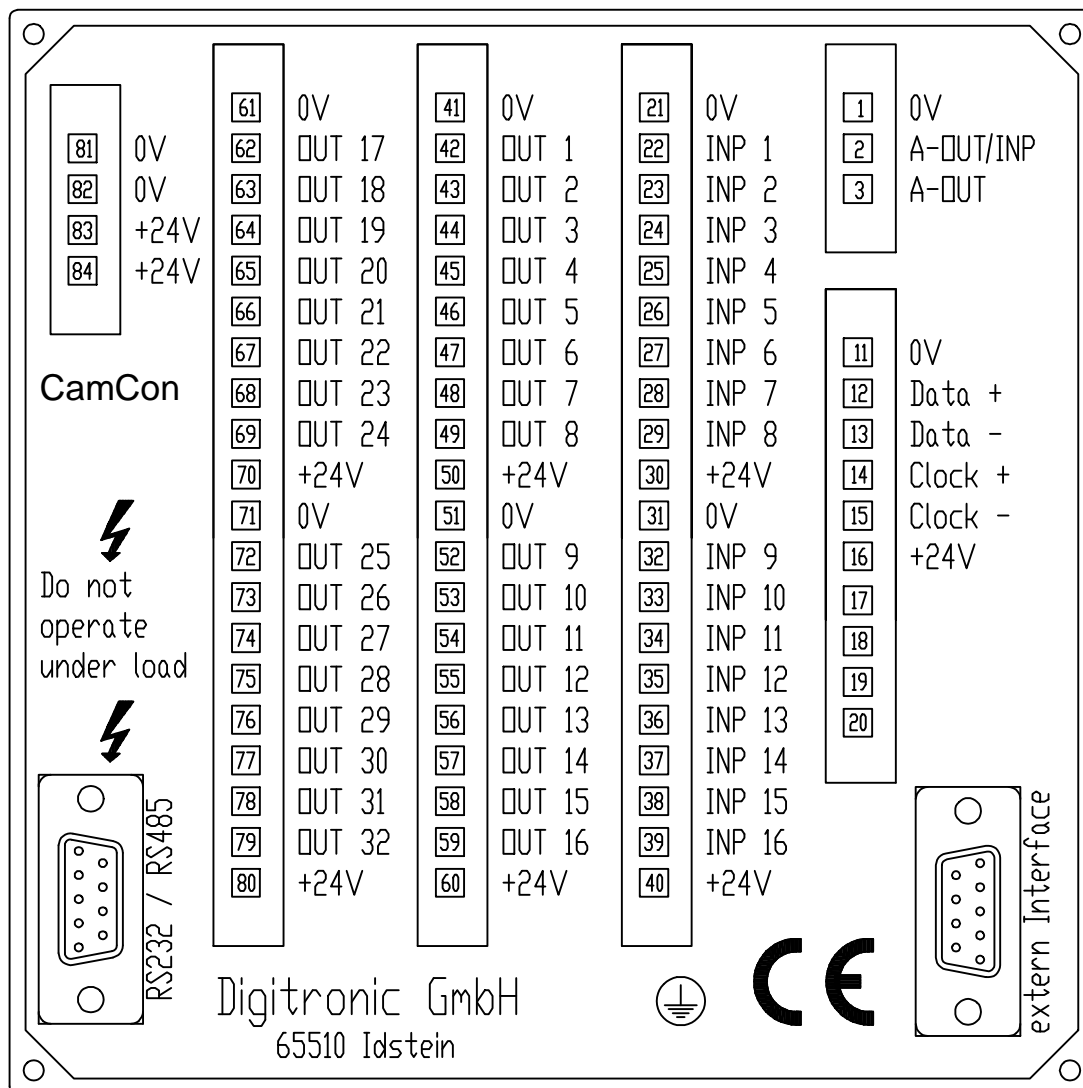

Fig.: Backview of the CamCon with pin allocation

4.1.1. Pin allocation if two analog outputs (option)

Pin	1:	0V signal mass for the analog output
Pin	2:	Analog output 1
Pin	3:	Analog output 2

4.1.2. Pin allocation if one analog input and one analog output (option)

Pin	1:	0V signal mass for the analog output and input
Pin	2:	Analog input 1 / -10V..+10V or 0..20mA
Pin	3:	Analog output 1 / -10V..+10V, 0..20mA or 4..20mA

4.1.3. Pin allocation of the SSI measuring system

Pin	11:	0V voltage supply for the SSI measuring system (encoder)
Pin	12:	Data A or +
Pin	13:	Data B or -
Pin	14:	Clock A or +
Pin	15:	Clock B or -
Pin	16:	+24V DC voltage supply for the SSI measuring system (encoder)

4.1.4. Pin allocation of the incremental measuring system

Pin	11:	0V voltage supply for the incremental measuring system (encoder)
Pin	12:	A Imp. (+)
Pin	13:	A Imp. (-)
Pin	14:	B Imp. (+)
Pin	15:	B Imp. (-)
Pin	16:	+24V DC voltage supply for the incremental measuring system (encoder)
Pin	17:	C1 Imp. (+)
Pin	18:	C1 Imp. (-)
Pin	19:	C2 Imp. (+)
Pin	20:	C2 Imp. (-)

4.1.5. Pin allocation of the inputs

Pin	21:	0V signal mass for inputs
Pin	22:	Input 1
Pin	23:	Input 2
Pin	24:	Input 3
Pin	25:	Input 4
Pin	26:	Input 5
Pin	27:	Input 6
Pin	28:	Input 7
Pin	29:	Input 8
Pin	30:	+24V DC voltage supply for the outputs 1 to 16
Pin	31:	0V signal mass for inputs
Pin	32:	Input 9
Pin	33:	Input 10
Pin	34:	Input 11
Pin	35:	Input 12
Pin	36:	Input 13
Pin	37:	Input 14
Pin	38:	Input 15
Pin	39:	Input 16
Pin	40:	+24V DC voltage supply for the outputs 1 to 16

4.1.6. Pin allocation of the outputs

Pin	41:	0V voltage supply for the outputs 1 to 16
Pin	42:	Output 1
Pin	43:	Output 2
Pin	44:	Output 3
Pin	45:	Output 4
Pin	46:	Output 5
Pin	47:	Output 6
Pin	48:	Output 7
Pin	49:	Output 8
Pin	50:	+24V DC voltage supply for the outputs 1 to 16
Pin	51:	0V voltage supply for the outputs 1 to 16
Pin	52:	Output 9
Pin	53:	Output 10
Pin	54:	Output 11
Pin	55:	Output 12
Pin	56:	Output 13
Pin	57:	Output 14
Pin	58:	Output 15
Pin	59:	Output 16
Pin	60:	+24V DC voltage supply for outputs 1 to 16
Pin	61:	0V voltage supply for the outputs 17 to 32
Pin	62:	Output 17
Pin	63:	Output 18
Pin	64:	Output 19
Pin	65:	Output 20
Pin	66:	Output 21
Pin	67:	Output 22
Pin	68:	Output 23
Pin	69:	Output 24
Pin	70:	+24V DC voltage supply for the outputs 17 to 32
Pin	71:	0V voltage supply for the outputs 17 to 32
Pin	72:	Output 25
Pin	73:	Output 26
Pin	74:	Output 27
Pin	75:	Output 28
Pin	76:	Output 29
Pin	77:	Output 30
Pin	78:	Output 31
Pin	79:	Output 32
Pin	80:	+24V DC voltage supply for the outputs 17 to 32

4.1.7. Pin allocation of the voltage supply

Pin	81:	0V voltage supply for the CPU
Pin	82:	0V voltage supply for the CPU
Pin	83:	+24V DC voltage supply for the CPU
Pin	84:	+24V DC voltage supply for the CPU

Attention : Pins 30, 40, 50 and 60 are connected to each other.
Pins 1, 11, 21, 31, 41, 51, 61, 71, 81 and 82 are connected to each other.

4.1.8. Pin allocation of the serial interface

When you order the CamCon you can choose the type of the serial interface between RS232 or RS485. Wiring and connector allocation are different for each type of the serial interface.

4.1.8.1. Pin allocation of the serial RS232 interface

DSUB 9 pinboard: RS232 Interface for PC attachment (max. 15m cable length)

Pin	1,4	Do not connect !
Pin	2	TXD
Pin	3	RXD
Pin	5	Mass
Pin	6-9	N.C.

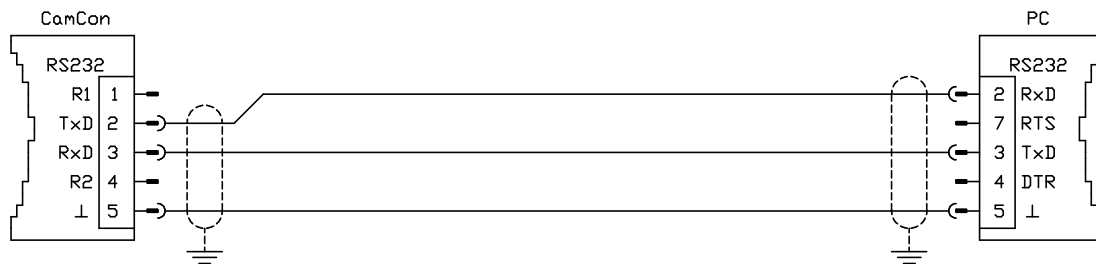

4.1.8.2. Pin allocation of the serial RS485 interface

DSUB 9 pinboard: RS485 Interface for PC attachment or for the networking of many devices (max. 1000m cable length).

Pin	1,4	Closedown resistors for RS485
Pin	2	B (-)
Pin	3	A (+)
Pin	5	GND
Pin	6-9	N.C.

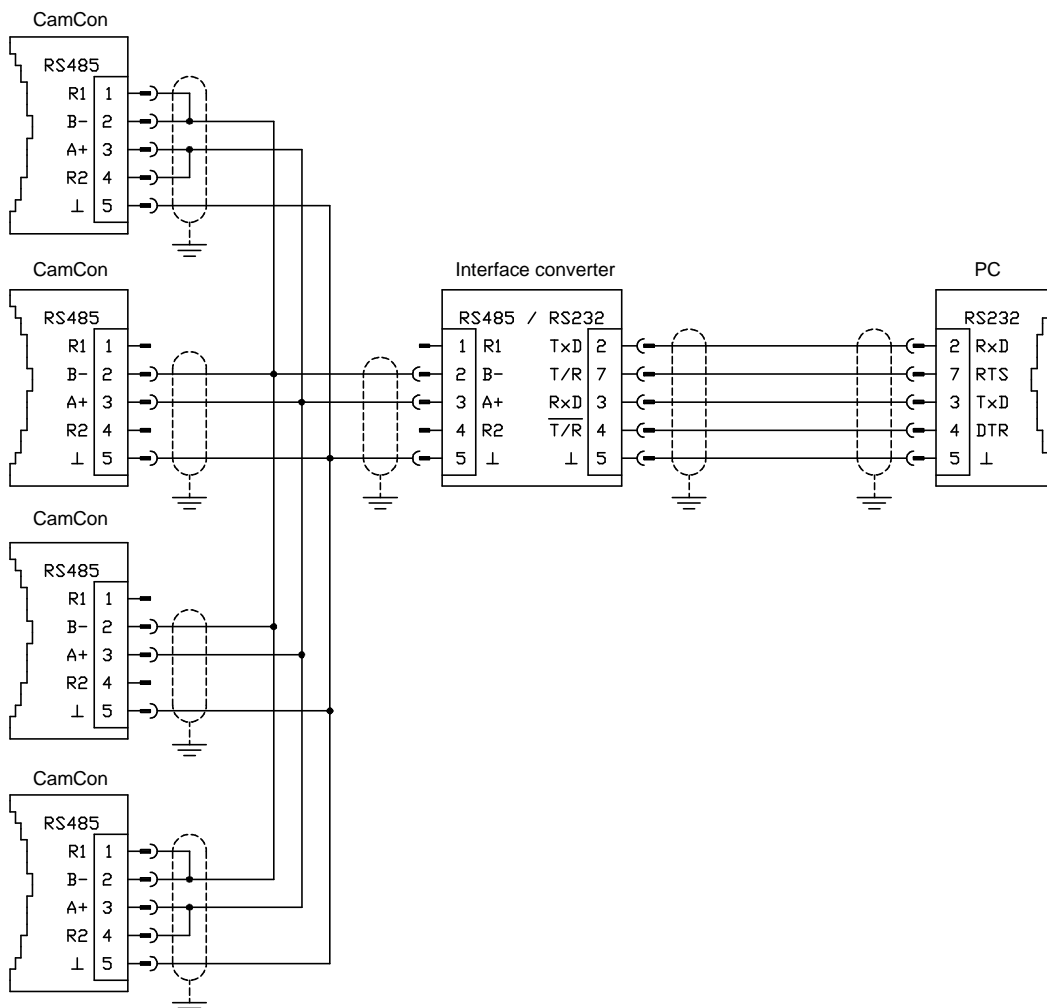
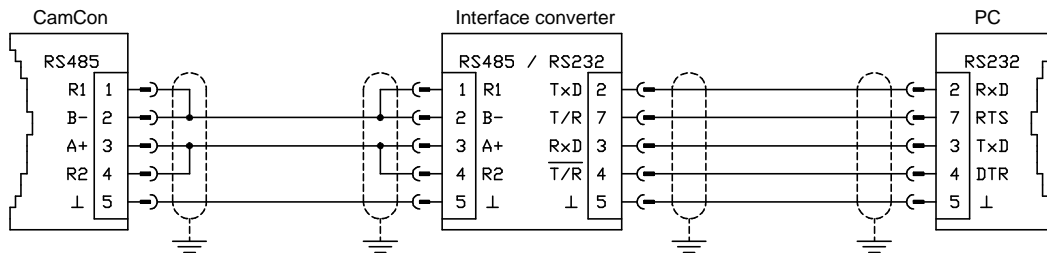

Note: The pins 1 and 2, as well as the pins 3 and 4 have to be bridged in the attachment plug of the first and last device in a networked chain at the RS485 Interface, to close the data and reception line perfectly. Corresponding closedown resistors are attached to the system at pin 1 and 4.

4.1.9. Pin allocation of the external interface

If you ordered the external interface along with the CamCon, you have the possibility to extend your CamCon by a CamCon DC91/IO, DC92/I or DC16/IO. The extensions are clipped on to a rail in the clipboard. They are connected with a cable with 6 poles, type "KK91/IO-XX" with the 9pole D-Sub male plug "external Inter in" at the CamCon module (maximum cable length is 300m). The data transfer is done through optical couplers, so that the connection remains potential free.

For the CamCon DC16/IO a DSUB cable with flatwire adapter can be ordered, order No. "KK50-16/IO-XX" (Note: XX refers to the cables length in meters).

DSUB 9 socket: link of external in - and output modules e.g. DC91

Pin 1,4,7	GND
Pin 2	TxD +
Pin 6	TxD -
Pin 8	CLK +
Pin 3	CLK -
Pin 5	RxD +
Pin 9	RxD -

Connection cable CamCon DC91/IO

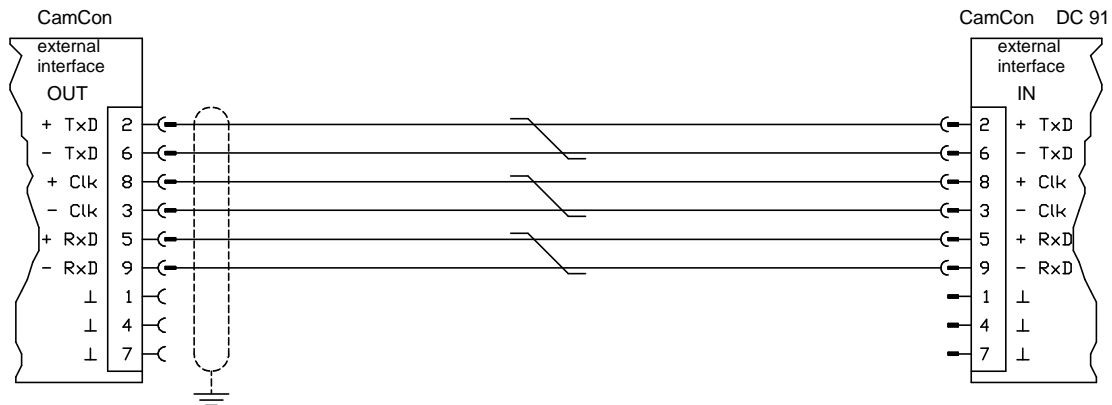

Connection cable CamCon DC91/IO

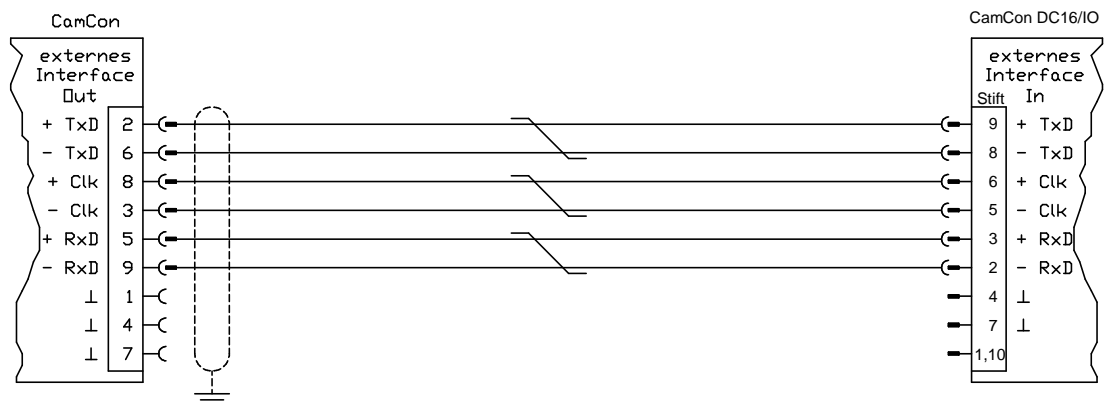

4.2. The measuring system

The measuring system is designed to record the necessary actual values (positions) for the Cam Switch Unit. Many different measuring system can be linked with the CamCon.

See chapter "4.1. Pin allocation" on page 15 and for adjustment of the measuring system to the software of the CamCons please also consult Chapter "7.4.1. Measuring system" on page 46.

Note: Please also consult the instruction manual for your measuring system.

4.2.1. SSI Measuring system input

Systems with a synchronous series interface = SSI. The SSI interface is widely used in industry for absolute single and multi-turn angle encoder. At this interface the CamCon supplies the measuring system with 24Volt. For the purpose of data reading the CamCon sends a stroke signal (clock) with RS422 level to the measuring system. This answers synchronously with the data output of the position in the grey code. The frequency of the pulse signal depends on the length of the cable to the measuring system and can be set in the CamCon.

Note: The data record corresponds to the Stegmann SSI Standard!

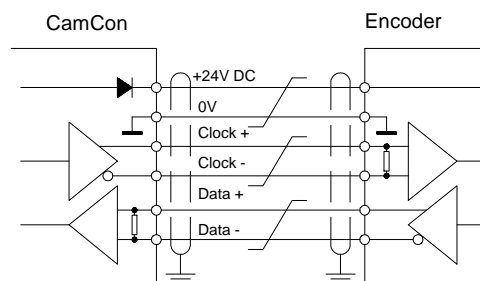
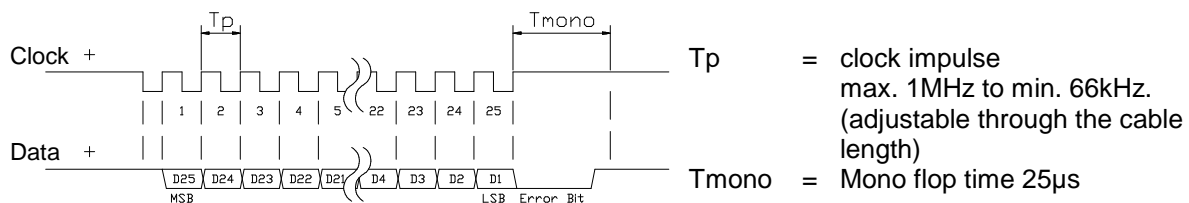

Please note:

Use a screened dual strand connection cable. Do not place the cable parallel to a high voltage cable. If possible, lay the screening down on both sides.

4.2.2. Parallel measuring system input

Systems with parallel 24V data leads, e.g. single turn - angle encoder or via a transformer with parallel data output.

In this instance a gray or binary encoded value is attached to the free inputs of the CamCon and this will be read as actual value. Since the connection cable are quite expensive and the EMV - compatibility is limited, this interface type is rarely used in industry nowadays.

Note: Since the outputs are partly switched parallel to the inputs in CamCon DC16, DC115, DC300 and CamCon 1756-DICAM, these must not be programmed under any circumstances and this reduces the number of available outputs.

Warning: Reading a binary encoded value into the CamCon is only permitted after consultation with the Service department of the company Digitronic.

4.2.3. Incremental measuring system input

Systems with 90° phase shift signals such as turning angle encoders, glass measuring rods or flow measuring devices.

At the present time incremental measuring inputs for the CamCon DC16/50/51/115/300 and DC1756 are available as an option. We differentiate between three signal levels:

- 24V PNP Signal inputs (Order number Option: J)
- 5V RS422 Signal inputs (Order number Option: I)
- Hiperface Signal inputs (Order number Option: H)

Note: For the CamCon DC16 and DC300 only the version with 24V PNP signal is available. For the CamCon 1756-DICAM the version with 24V PNP signal and Hiperface Signal is available. If a different signal level is necessary, this can be converted externally with the INCDRV converter.

In all cases the CamCon supplies the measuring system with 24Volt/DC or in CamCon DC115 optionally with 5 or 24Volt/DC. As a counting signal the measuring system gives out two impulses at a time shifted by 90°. These are counted in the CamCon and are evaluated as position values. In addition, for each rotation another zero impulse (Clear 1) is given out for synchronisation purposes. In order to stop synchronisation (zero setting) of the counter, a further clear signal (Clear 2) is available on the CamCon.

The signals Clear 1 and Clear 2 are to standard AND linked and can be changed in their function with the software. See Chapter "7.4.1.6.3. Incremental - measuring system" on page 50

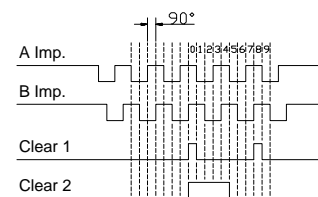

4.2.3.1. Incremental measuring system input with 5V RS422 level

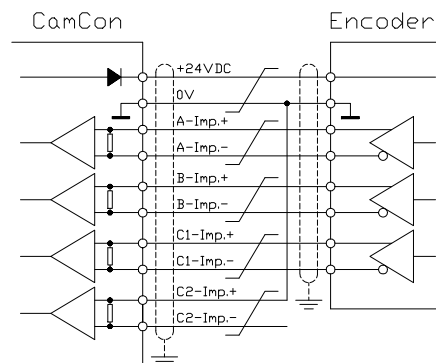

If the 5V RS422 system is used, all signals of the measuring system input must be active, otherwise the input conditions are undefined. If no signal is available for one of the two Clear inputs, then this input must be switched to mass on the (+) signal in order to switch the input to low. The inputs of the measuring system can be activated with a maximum voltage of 5V. Please pay attention to the power supply of the angle encoder which can be 5V as well as 24V. Only the CamCon DC115 can at present provide a voltage of 5V for the supply of the angle encoder.

4.2.3.2. Incremental measuring system input with 24V PNP level

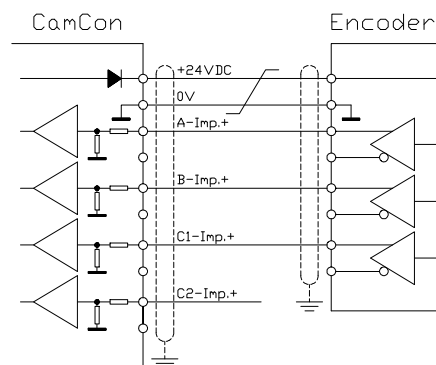

If a 24V PNP signal is used for data input, then only the (+) signals of the inputs may be connected. The (-) signals must stay inactive in this case. The connection of such a measuring system requires a change of the internal switch system and must therefore be stated on the order form.

Note: At the incremental input of the CamCon DC16, DC300 and DC1756 no (-) signals are available.

4.2.3.3. Incremental Hiperface measuring system input with SINCOS level

The Hiperface measuring system is a feedback system for servo-motors of the company Stegmann.

It is a mixed system and consists of an absolute measuring system and an incremental measuring system. The absolute measuring system sends its values via RS485 interface to the counter. The incremental measuring system works with analog sine - and cosine interface with a resolution of 512 or 1024 impulses per revolution.

The CamCon with the Hiperface signal input (option: H) reads only the incremental sine - and cosine signal. The signals are converted and counted in the CamCon into normal incremental measuring system signals.

Since the absolute measuring system of the Hiperface interface is not used and no clear - signals are available, the CamCon must be initialized after each restart.

This must be done by the preset input of the CamCon. See for this to chapter 7.4.2.4. Actual position preset on page 57.

Note: The maximum number of revolutions per minute is 3000 min^{-1} with 512 Impulse per revolution. The maximum number of revolutions per minute is 1500 min^{-1} with 1024 Impulse per revolution.

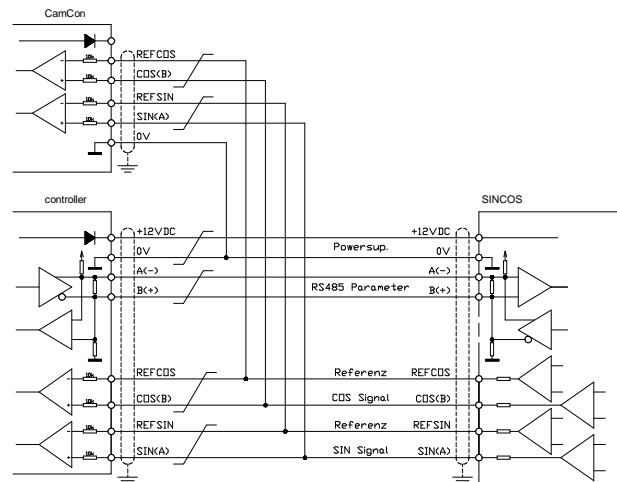

4.2.4. Analog measuring system input

These are systems which receive their actual value through conversion of current or voltage signal, such as temperature or pressure sensors.

For the recording of analog signals the analog to SSI conversion module AWA/SSI in 8 and 12 bit resolution is available for the CamCon. This module is connected to the SSI of the CamCon and is switched ON through the selection of the analog measuring system in the menu "Measuring system".

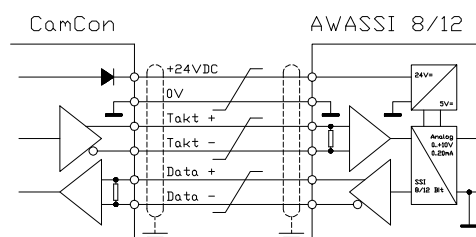

4.2.5. PLL measuring system input

Systems with Phase - Lock - Loop data recording. In these systems the actual value is found through interpolation of initiator impulses. This measuring system is applied to machines with constant speed and with a cyclic pulse.

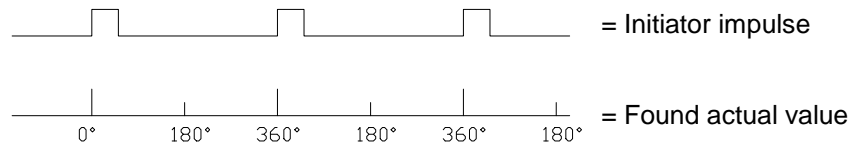

The Initiator can be connected to any free input of the CamCon.

Note: For CamCon DC115 a special input is available on the 25pol. SUB-D plug.

See also chapter "7.4.1.6.5. PLL measuring system" on page 52.

4.2.6. Timer as a measuring system

Systems which are controlled by elapsed time. In this case the CamCon makes a time available with a time basis of minimum 1 ms as actual value. Through laying on of input signals it is possible to influence the elapsed time. This measuring system is applied to machines with a fixed time scanner as a control feature, e.g. washing machines.

See also chapter "7.4.1.6.6. Timer way simulation" on page 52.

4.2.7. RS232 as a measuring system

Systems, receiving their actual position through the RS232 interface, e.g. for a junction of a Stegmann POMUX linear scale to a RS232 data output.



Warning The activation of this measuring system blocks the RS232 interface for programming. This measuring system is only reasonable with a CamCon DC50/51.

4.3. The outputs

The CamCon has, concerning each upgrading level, up to 32 outputs and with extreme extension (e.g. CamCon DC16/IO, DAC16 or DC91/IO) up to 200 short circuit-proof outputs. They deliver 24Volt high active signals and are not potentially free towards the CPU. The outputs 1 to 16, as well as 17 to 32 of the unit have to be supplied with 24Volt, because the power supply of the outputs has been separated in order to achieve a better power distribution.

4.3.1. The 40mA outputs (only CamCon device with aluminium back wall)

If all outputs are activated, not more than 40 mA permanent current in the complete temperature range should be extracted per output, else the unit will deactivate with an error message. If a higher starting performance is required, one has to know that the outputs are combined in 4 groups, each group consisting of 8 outputs. Within each group, 480 mA permanent current at a surrounding temperature of 50°C, and at a surrounding temperature of 25°C even 700mA permanent current is available. This permanent current can be distributed freely within a group, as long as the single output current of 300 mA is not overshoot (see chapter "7.4.6.2. Setting the outputs" on page 65).

4.3.2. The 500mA outputs

At a surrounding temperature of 25°C even 500mA permanent current is available for each output. If your outputs are overloaded or short-circuited the unit will deactivate with an "out-err" message (see chapter "7.4.6.2. Setting the outputs" on page 65).



Attention: For inductive loads the inductances have to be tripped with a freewheeling diode.

4.4. The inputs

The CamCon has, concerning each upgrading level, up to 16 inputs and with extreme extension up to 200 inputs. These inputs work with high externally active 24Volt signals and are not potentially free towards the CPU.

The input wiring:

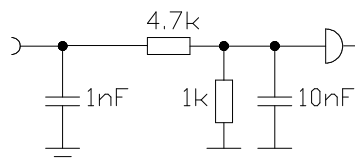

The input resistance is about 5.7 KOhm.

The inputs of the CamCon have not been covered with functions by the factory. The user would have to do this himself in the process of setting system data of the CamCon depending on his requirements. See chapter "7.4.6. System upgrading" on page 65, chapter "7.4.1. Measuring system" on page 46, chapter "7.4.6.8. Setting the external program selection" on page 66 and chapter "7.4.6.5. Setting the keyboard lock" on page 65.

4.5. Precautionary measures for welding work

Attention: For the duration of welding operations carried out at the machine, the connecting wires concerning the data exchange from the measuring system to the CamCon and the power supply as well as the grounding connections and inputs and outputs have to be separated from the CamCon.



5. Outline of the operator terminal

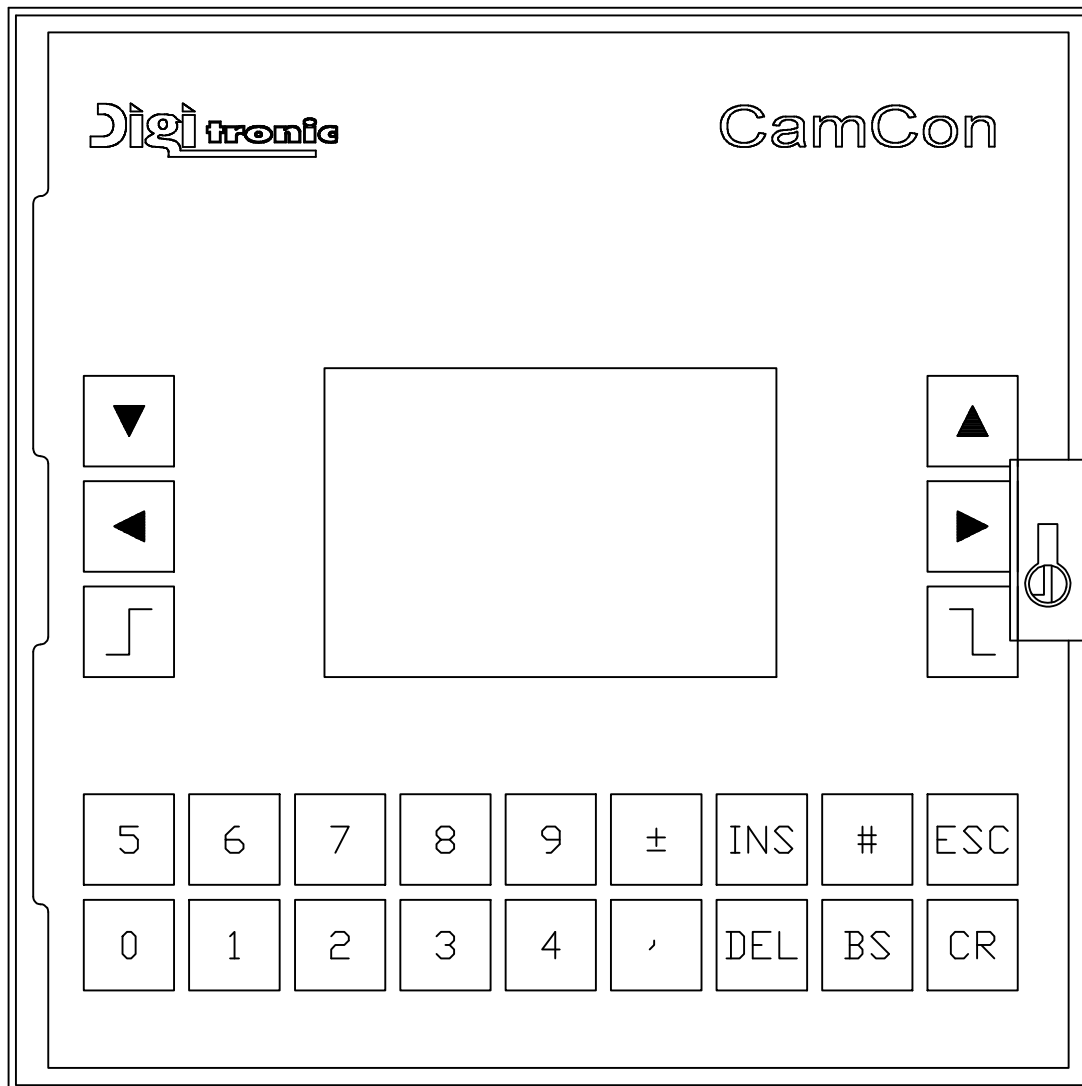

5.1. Frontview CamCon



5.2. The liquid crystal display (LCD)

The display unit of the CamCon 50 contains a graphical LCD with 128x64 picture elements. For the visual user prompting, all menus concerning the programming of the unit, state and error messages of the outputs, as well as the current position and speed, are represented here. The contrast can be adjusted to the current surrounding temperature with the keyboard.















5.3. Contrast setting

You can increase or decrease the contrast of the LCD in this display mode with the  and  keys. Keeping these keys pressed continues the change of contrast.



5.4. The keyboard

The plastic foil keyboard of the CamCon is non-sensitive towards dirt and is solvent resisting. The keys have a noticeable action point for the tactile feedback, as well as an acoustic input acknowledgement (see chapter 7.4.6.4.7.4.6.5. Setting the keyboard lock on page 65).







5.5. Outline of key functions

	cursor down
	cursor up
	cursor to the left, shifting cams
	cursor to the right, shifting cams
	choose cam activation point, character selection during text input, (or PC 'PageUp' key)
	choose cam deactivation point, character selection during text input (or PC 'PageDown' key)
	input of cams, special measuring systems, character during text input
	place holder for display formats, reset during error messages, special functions
	Escape: leaving the current menu, returning to the next higher menu
	deletion of cams, outputs, programs and single characters during text input
	deletion of single characters during text input
	confirm input and save data
	changes the algebraic sign during data input
	comma
	numeric keys for data input









5.6. Menu selection



You can select a desired menu by pressing the corresponding numeric key or by moving the cursor (the black beam) on the menu name with keys  and  and pressing the  key.







5.7. Selection of a menu point

The input in the single menus is subdivided into menu points. These are active (or selected), if the display is inverted. The selection of these menu points is made with keys , ,  and  and a confirmation of your choice with the  key. You can always cancel an input by pressing the  key. If you pressed a wrong key, the unit shows a hint of the keys you can use in this menu and their functions.

5.8. Text input

With menu points, in which texts have to be implemented, the  and  keys function together with the  and  keys like a coordinate control. You select the desired position for the first character, using the  and  keys. Then you can choose the character with the  and  keys, by going up and down through the alphabet or the ASCII characters. If you move the cursor to the right with the  key, character entered prior to this will appear in the new position of the cursor, simplifying making repeated inputs of the same character.

If you have made an error you can go back to the wrong character to correct it, using the  key or the  key. This will cause the other characters to become erased. To abandon the input press the  key.

Attention: The software for the text input at the CamCon has changed since EPROMS of 1/97. The selection of desired characters is now realized with keys  and . With keys  and  you can now position the cursor anywhere in the previously entered text. You can overwrite characters, insert characters by pressing the  key or delete characters with keys  or .

Note: The text input is also possible directly via PC.

6. Commissioning

Before switching the device on for the first time, please check its wiring (see chapter 4.1. Pin allocation on page 15).



Attention: *With induced loads the outputs have to be switched with a freewheeling diode. Covers or inductivities very close to the device inside the switchboard have to be switched with a deletion unit as do those that are wired to or influence the wiring of the device.*

After being switched on the CamCon will generate a short tone. Afterwards it will start the internal review and the running up of the system (e.g. to generate the proof total of the EEPROM and the EPROM). This process takes several seconds. After a successful installation of the system, the standard display (the current program number, the position and the speed, as well as a possible error message) is displayed. Once the system registers are brought in accord to the measuring system and it is wired correctly, there should be no further error messages.

After first activating the supply voltage, the program memory is not in a defined state. So when first using the CamCon unit you have to put a complete deletion into operation as follows:

1. Press the **ESC** key, you leave the standard display and enter the main menu:
2. Select the menu point "Unit configuration", the request to enter your user code is displayed on the LCD:

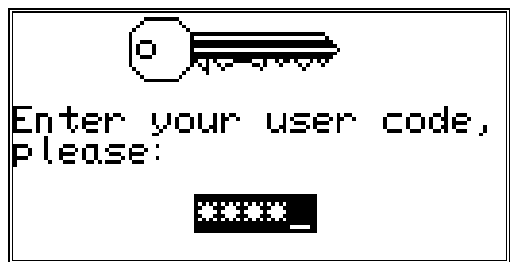
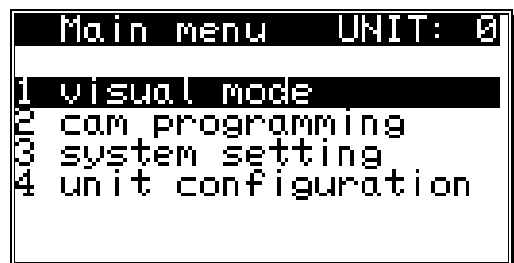

3. Enter your user code. If you have not programmed your own key, use the standard key number "5693"!

4. Press the **CR** key to confirm your user code. If a false code is entered, "Wrong user code!" is shown on the display. In this case, press any key, and reenter the code. The display returns to the main menu after about 30 sec., if no numbers are entered or the input is not confirmed with the **CR** key.

After the correct user code is entered, the display shows the configuration menu.

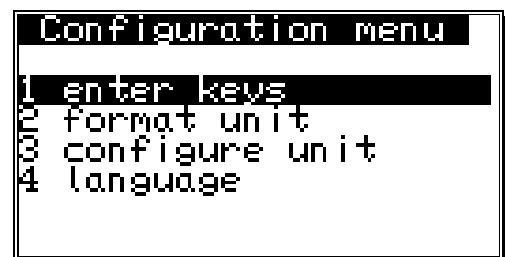

5. Select the menu point "Format unit", the following question is displayed:



6. Move the cursor to "yes" with the **←** key.
7. Press the **CR** key.

After about 5 sec. the display returns to the configuration menu. This waiting time depends on the size of the used EEPROM, since the memory has to be formatted. With the use of a 32k - EEPROM it is increased to approximately 2 min. After this time the complete deletion is finished. All cams are erased, all system registers have the standard value.

Now you can begin with the system setting.

To make your device operable, you have to set a minimum number of parameters on your CamCon. This is the recommended order of the parameterization. You can find the necessary information in the corresponding chapters.

- 1) System setting, System upgrading See chapter "7.4.6. System upgrading" on page 65.
- 2) System setting, Cable length See chapter "7.4.4.1. The cable length" on page 60.
- 3) System setting, Measuring system See chapter "7.4.1. Measuring system" on page 46.
- 4) Unit configuration, hardware configuration, See chapter "7.5.6. Configure Hardware" on page 77.

If you have adjusted the inputs according to the corresponding chapters, the CamCon is ready and no more error messages should occur. Of course we recommend to go through the whole system setting menu to receive a maximum of user ability and comfort.

After the system setting you can begin with the cam programming.

7. Operation of the CamCon

7.1. The main menu

The programming always starts at the main menu. No matter in which state of programming you are, you can always reach the main menu by pressing the **ESC** key (several times, if necessary).

By pressing the corresponding number or by selection with keys **▼** and **▲** and a verification with the **CR** key, you can enter the submenus.

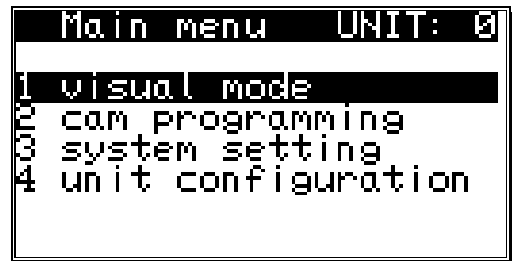

7.2. The standard display

You reach the submenu for the display for normal operation of the cam controller via the main menu point "Visual mode" or by pressing the **ESC** key (at the main menu).

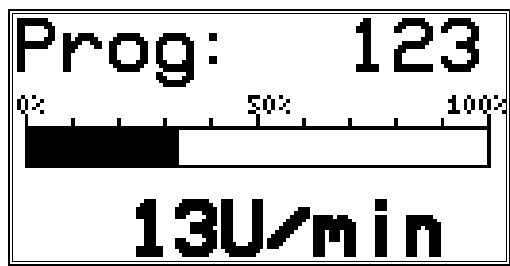

In the display menu, the active program number, the relative speed as a bar (e.g. for an analog speed output) and the current actual position, respectively the absolute speed (with higher rotational numbers), are displayed. If the measuring system is put into a slow motion the respective actual position is shown on the display. With increasing rotation velocity the device switches at a defined point (5%) to a display showing the current speed in the desired representation; a negative direction in the rotation is shown through a negative sign in front of the

displayed value.

The configuration of the speed display is done in the system setting menu. Here you can e.g. disable the automatic change of the display, by selecting a certain display type (see chapter "7.4.3. The speed adjustment" on page 58).

7.2.1. Changing the display

If you want to receive status information of in- and outputs during operation, you can switch through the several status displays, using keys **◀** and **▶**. The display then shows an outline of operation for inputs and outputs:

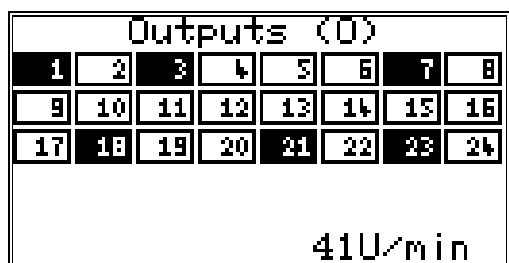

Output display

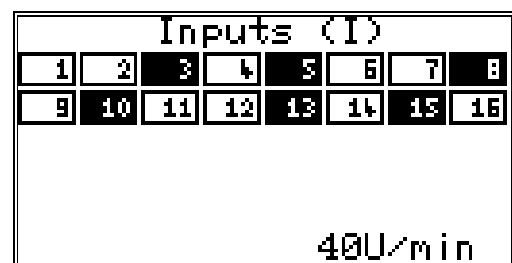

Input display

As soon as an in- or output activates, its field on the display turns black.

In the lower righthand corner of the display, you can see the current position or the absolute speed at a faster movement.

7.2.2. Program change

With the CamCon you are capable of storing several programs. To choose one of these programs you have to be in the standard display. The selection of a desired program is done as follows:

1. Press the **CR** key, the display shows the request for your user code.
2. Enter your user code.
3. Press the **CR** key, the cursor goes to the menu field of the program number.

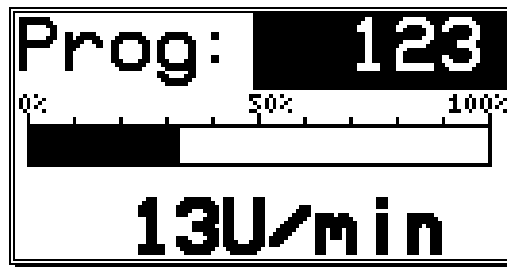

4. Enter program number with the numeric keys
5. Press the **CR** key to complete your input

The CamCon will change programs according to the program selection parameters you entered. If the process takes longer than one second, the display will blink until the selection is complete see chapter "7.4.6.9. Setting the program selection mode" on page 66.

7.2.3. Program name

With the CamCon you can assign a text to the stored programs. This is recommended when important information needs to be linked to the program number (e.g. a toolnumber or the name of a product). The input of the program name is done as follows:

1. Press the **CR** key, the display shows the request for your user code
2. Enter your user code
3. Press the **CR** key, the cursor goes to the menu field of the program number
4. Press the **#** key, the cursor goes to the text input of the program number

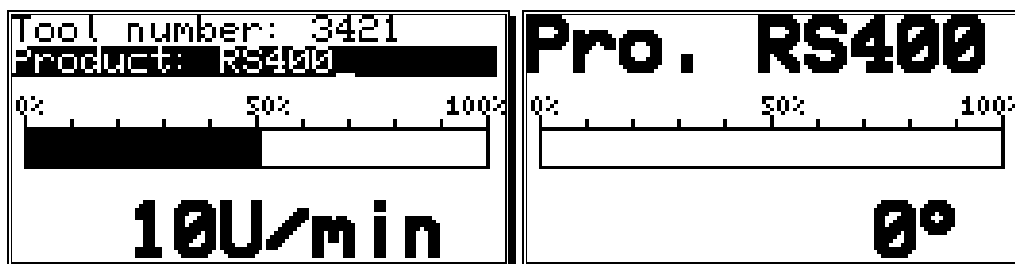

Here you can enter a name for your program (see chapter "5.8. Text input" on page 28).

5. Confirm your input with the **CR** key

The presentation of the program name changes with the length of the input text. 2 lines with 21 characters each or 1 line with 10 characters can be displayed.

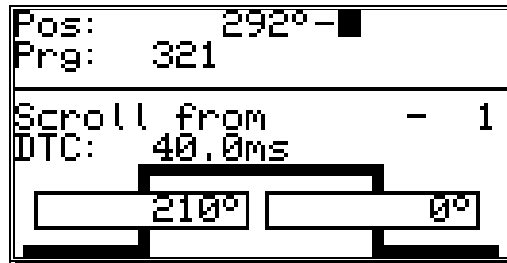

7.3. Cam programming

To get to the actual cam programming select "**Cam programming**" in the main menu. The display switches to the programming menu:





The upper part shows the current actual position, the switched state of the selected output and the chosen program. The lower part displays an output with programmed cams and their activation and their deactivation points. If no input is made within two minutes the CamCon automatically returns to the main menu for reasons of safety.

7.3.1. Output selection for programming

You can select the desired output by pressing the  and  keys.

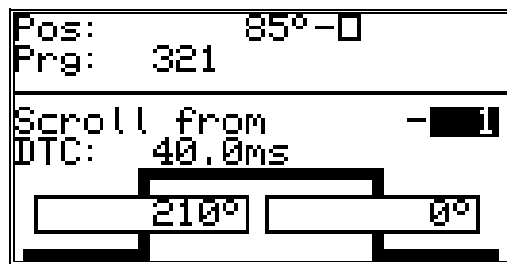
By pressing the  key you reach the direct input of the output number.



With the numeric keys you can select the number of the output you want to select. Confirm your selection with the  key.

7.3.2. Program selection for programming

You reach the input of the output number by pressing the **CR** key. You skip this by pressing the **▲** key and enter the program selection for the programming.

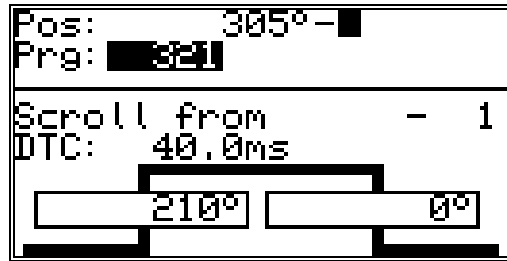

Enter the number of the desired program by using the numeric keys. Confirm your input with the **CR** key.



A change in the program number does not lead to a change in the momentarily active cam program. This means: You can program a program while another program operates the outputs.

7.3.3. Programming the delay time/speed compensation

You reach the input of the output number by pressing the **CR** key. You skip this by pressing the **▼** key and enter the delay time you want to compensate.

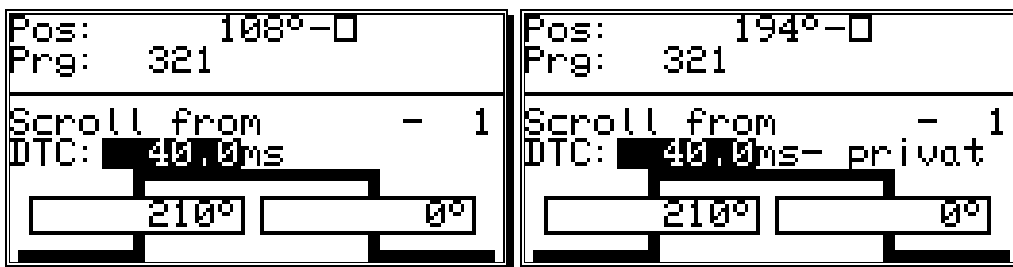

With the numeric keys you can enter the delay time that you need to compensate.

By pressing the **▼** key while entering, the effects of the speed compensation for the switch - on - and switch - off - point will be switched separately and the second delay time value can be fed in.

This separated speed compensation can be deleted by pressing **DEL** while entering the second delay time value.

Attention:

If the offswitchpoint overtakes the onswitchpoint at rising speed, the result will be a non-defined signal.

By pressing the **#** key with the input you can limit the effect of the delay time to the program you are programming (private). A renewed pressing of the **#** key takes on the standard speed compensation for this program.

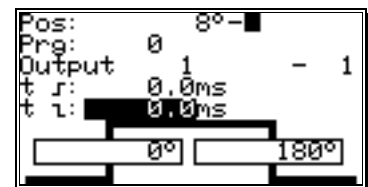

Confirm your input by pressing the **CR** key.

References to the speed compensation works can be found in chapter "2.1. Speed Compensation" on page 9.



7.3.4. Programming a Not - Linear - Speed compensation (NLT)

With the NLT - Speed compensation you are able to compensate a not linear movement like acceleration or brake ramps.

The NLT can activate by press the  key if the cursor is at the menu point to enter the speed compensation value.

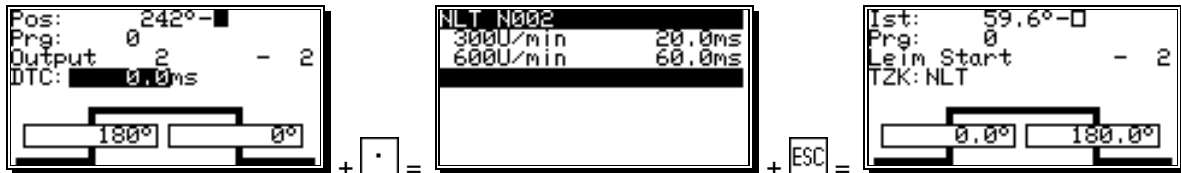
Note: The NLT is not possible on a seperated speed compensation with "on" - and "off" - switch point.





To insert a new base point for a speed value in the NLT table you press the key . If you press the  on a already existing speed base point, the value of the speed and speed compensation can change. If you press the  key on a existing base point, this base point will delete. If the last base point is delete the NLT function is switch off.

If you press the  key the NLT - menu can quit.

Attention: To programme a NLT Speed Compensation, the NLT have to switch on globally. See chapter "7.4.6.3. Setting the outputs with speed compensation" and chapter "7.4.6.4. Setting of the Not - Linear - Speed compensation(NLT)" on page 65.

7.3.5. Programming Time-Cams

By pressing  you get to enter the starting number, which can be adopted by confirming with key . After that, you are put forward to entering the delay time.

Attention: When programing a Cam, the specific output must have a switched speed compensation. Also see chapter "7.4.6.3. Setting the outputs with speed compensation" on page 65.

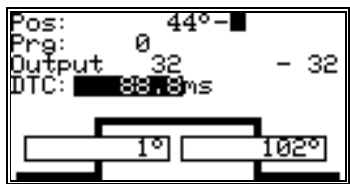

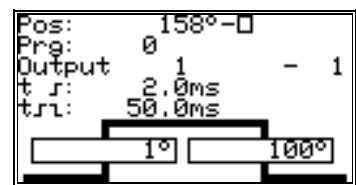

Using the numeric keys you can enter the delay time. Press while entering followed by pressing to switch on your way-Cam, so that you are able to enter the switching time in steps of 0.1 ms.

Pressing  while entering the switching time will switch of the Time - Cam.



Attention:

If the next Cam switching point reaches a Cam that is not yet switched off, both Cams will be summed up as one.

Pressing  while entering delay time or switching-time values can limit the effects of these values on the program that is worked on (private). A second  key will switch off the private input. This function can be switched on or off separately for delay- and switching time.

A  key will confirm these values and quit the input-section.

7.3.6. Programming the output name

You reach the input of the output number by pressing the **CR** key. You skip this by pressing the **◀** key and enter the input of the output name of this output.

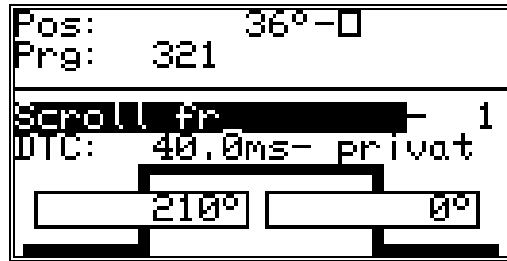

Here you can enter the output name via text input see chapter "5.8. Text input" on page 28.

7.3.7. Cam Input

By pressing the **↵** key you start the input of a cam. On the display the field for the cam activation point (left bar) is underlined in black, while a stylized cam blinks in the range of the two bars. With the numeric keys you enter the position for the cam activation point.

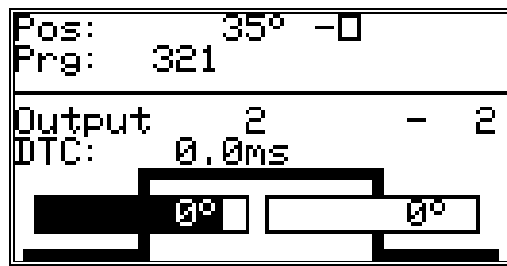

After you confirm your selection with the **CR** key, the field for the cam deactivation point is underlined in black. Simultaneously, the dropping flank of the stylized cam starts to blink.

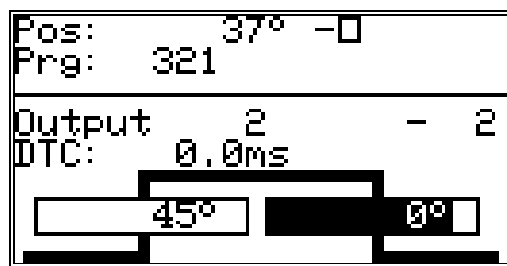

Enter the value for the cam deactivation point with the numeric keys and finish your input with the pressing of the **CR** key.

Remember: The maximum expansion of a cam can never reach a full rotation. For the programming of such a cam you have to program a security output (see chapter "7.4.5. The special outputs" on page 61).

7.3.8. Adding cams

In case you want to program additional cams on this output, you have to use the **INS** key. When you press this key the following is displayed on the display:

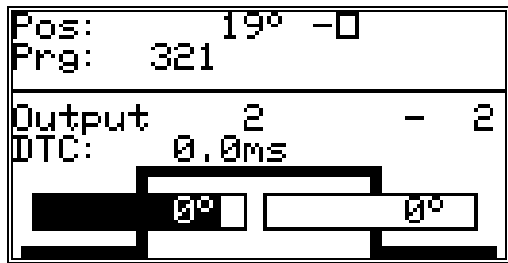

Here you can enter the positions for the activation and the deactivation point for the cam, as is described in the chapter "7.3.7. Cam Input". If you enter a cam that overlaps with an already existing cam, you create a single, greater cam.

Example: The previously configured cam lies between 50 and 120 degrees. If you now create a new cam between 90 and 180 degrees, these two cams are combined into a new cam from 50 to 180 degrees.

7.3.9. Cam Teach - In

If you are in an input field of an activation or deactivation point during cam programming, you can assume the current actual position for the field by pressing the **#** key. The actual position is displayed and brought up to date until the **J**, **L**, **CR** or **ESC** key is pressed to confirm the value or to abort the input.

7.3.10. Cam Search

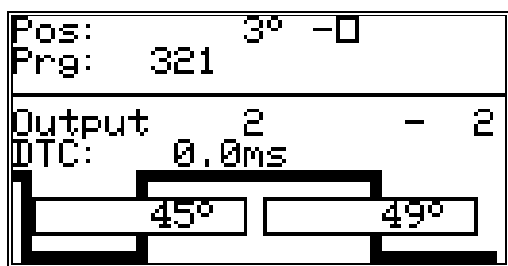

With the **◀** and **▶** keys you can call up and control the programmed cams. With each activation a single cam is displayed, and its neighbouring cams are shown as their flanks on the edges of the display.





The increasing course of the cam curvature on the right edge of the display points to another cam that is positioned between the cam deactivation point (180°) and the higher border of the measurement range (e.g.:359°). The left flank hints to the presence of additional cams between the cam activation point (45°) and the lower border of the measurement range (e.g.:0°).

With the **◀** and **▶** keys you can determine whether there are other programmed cams.

7.3.11. Cam deletion

If you want to completely erase a cam, select the cam using the  and  keys and press the  key, causing the following question to be displayed:



To delete the cam, move the cursor to "yes" with the  key, and press the  key to confirm your choice.

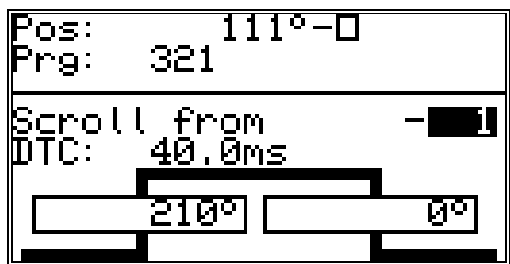

7.3.12. Output (cam track) deletion

If you want to completely erase an output (cam track), you have to press the  key to enter the input of the output number.

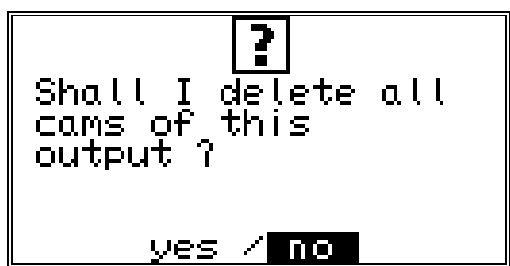

Now you can enter the number of the output you want to delete with the numeric keys. Press the  key and the following question is displayed:



Move the cursor to "yes" with the  key and press the  key to confirm your input.

7.3.13. Copying programmed outputs (cam tracks)

With the CamCon you have the option to copy all the cams you have programmed on one output to additional outputs. First press the **CR** key to enter the input of the output number. Select the output that you want to copy to the previous selected output with the numeric keys. Press the **#** key to start the copying process. The following question is displayed:

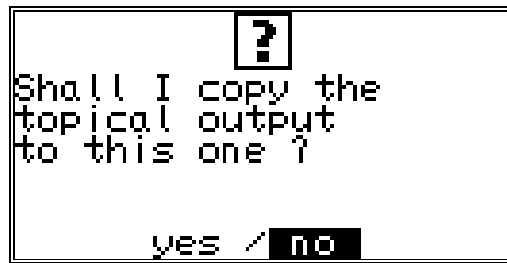

Move the cursor to "yes" with the **←** key and press the **CR** key to confirm your input. This starts the copying process. After a short while the new output will appear on the display.

7.3.14. Shifting cam tracks

With the CamCon you have the option to shift all the programmed cams of one output, using the **←** and the **→** key.

Press the **↵** or the **↵** key to enter the input of the activation or the deactivation point.

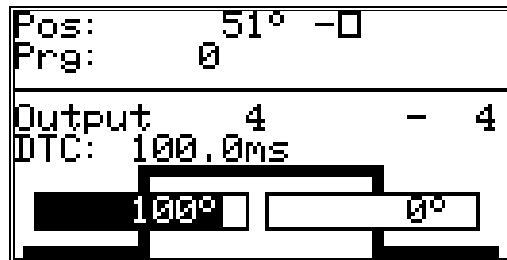

If you now press the **←** key or the **→** key, all the cams of this output are shifted by one increment. In this case the cams are directly taken over into the memory without the use of the **CR** key (unlike before). The shifting process is ended by pressing either the **CR** key or the **ESC** key.

7.3.15. Deleting programs

If you want to erase a whole program, you have to press the **CR** key to enter the input of the output number. Skip it by pressing the **▲** key, and you enter the program selection for programming.

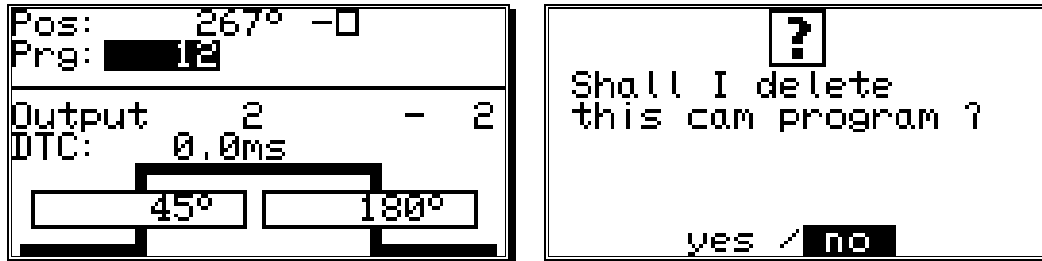

Enter the number of the program that you want to delete with the numeric keys. Press **DEL** and the display shows the security precaution question for the deletion of programs. Move the cursor to **"yes"** with the **◀** key, and press the **CR** key to delete the program.

7.3.16. Copying programs

With the CamCon you also copy whole programs. This is done as follows:

1. Press the **CR** key, the cursor moves to the input of the output number.
2. Press the **▲** key, the cursor moves to the input of the program number.
3. Select the program you want to copy using the numeric keys.
4. Press the **CR** key to confirm your selection.
5. Press the **CR** key, the cursor moves to the input of the output number.
6. Press the **▲** key, the cursor moves to the input of the program number.
7. Using the numeric keys, select the program onto which you want to copy the previously selected program.
8. Press the **#** key, to start the copying process. The display shows the question:

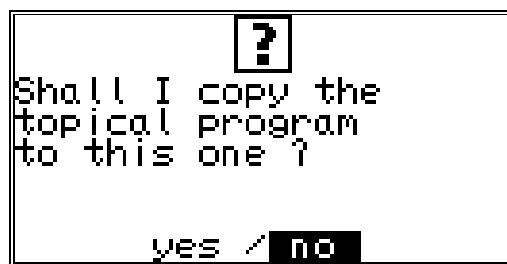

9. Move the cursor to **"yes"** with the **◀** key and press the **CR** key to confirm your input.

This finally initializes the copying process, and after a short while the new program appears on the display.

7.3.17. Examples for cam programming

7.3.17.1. First cam programming

Task: After a complete deletion of the program memory and a successful initialization of the system, a cam shall be programmed for output 4 from 100° to 200° with a speed compensation of 100ms

```
Pos: 123° -■
Prg: 0

Output 1 - 1
DTC: 0.0ms

-----
```

```
Pos: 231° -□
Prg: 0

Output 1 - ■
DTC: 0.0ms

-----
```

```
Pos: 51° -□
Prg: 0

Output 4 - 4
DTC: 100.0ms

-----
```

```
Pos: 51° -□
Prg: 0

Output 4 - 4
DTC: 100.0ms

100° 0°
```

```
Pos: 183° -□
Prg: 0

Output 4 - 4
DTC: 100.0ms

100° 200°
```

```
Pos: 185° -■
Prg: 0

Output 4 - 4
DTC: 100.0ms

100° 200°
```

Solution:

1. Choose the main menu point "**Programming**".
2. Enter your user code and press the **CR** key, to have the programming menu displayed.
3. Press the **CR** key and enter "4".
4. Press the **▼** key, the cursor moves to the field for speed compensation.
5. Enter the value "1000" with the numeric keys.
6. Press the **↵** key to enter the cam activation point. The cursor moves to the input field for the cam activation point. Simultaneously, a stylized cam starts blinking.
7. Enter the value "100" for the cam activation point with the numeric keys.
8. Press the **↵** key. The cursor moves to the input field for the cam deactivation point.
9. Enter the value "200" for the cam deactivation point with the numeric keys.
10. Press the **CR** key to confirm your input. The first cam is now programmed.
11. You can leave this menu any time by pressing the **ESC** key.

7.3.17.2. Programming additional cams on an output

Task: Program an additional cam from 300° to 330° in program 0, on output 4 with the cam from 100° to 200°.

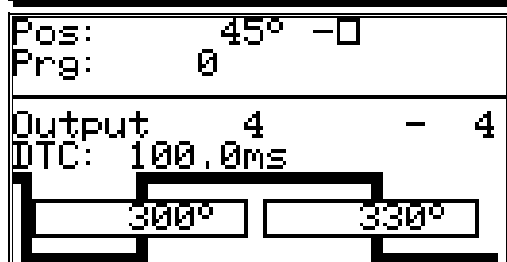
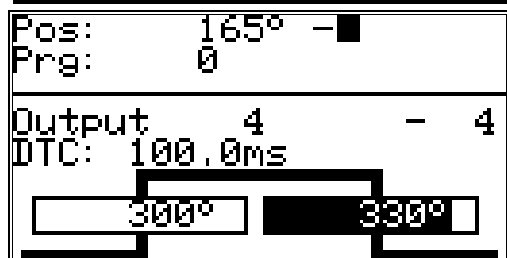
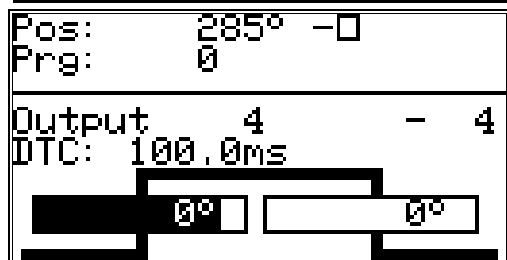
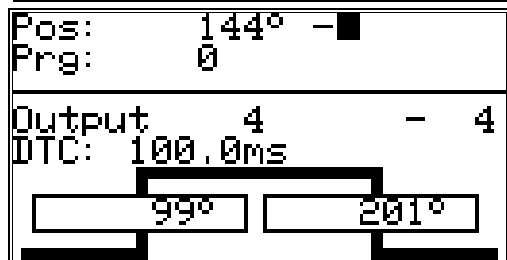
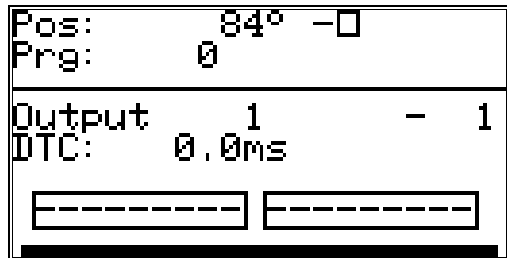

Solution

1. Select the menu point "programming" in the main menu.
2. Enter your user code and press the **CR** key. The programming menu is displayed:
3. Select output 4 with the **▲** key or press **CR**, enter "4" and press the **CR** key again.
4. Press the **INS** key to enter the cam activation point for an additional cam. The cursor moves to the input field for the cam activation point; a stylized cam starts to blink simultaneously.
5. Enter the value "300" for the cam activation point by using the numeric keys.
6. Press the **L** or the **CR** key. The cursor moves to the input field for the cam deactivation point.
7. Enter the value "330" for the cam deactivation point by using the numeric keys.
8. Press the **CR** key to confirm your input. The second cam is programmed.

The display shows the newly programmed cam as well as the cam between 100° and 200° as a flank on the left edge of the display.

9. You can leave this menu at any time by pressing the **ESC** key.

7.3.17.3. Deletion of a particular cam

Task: In program 0 the inserted cam between 300° and 330° shall be erased.

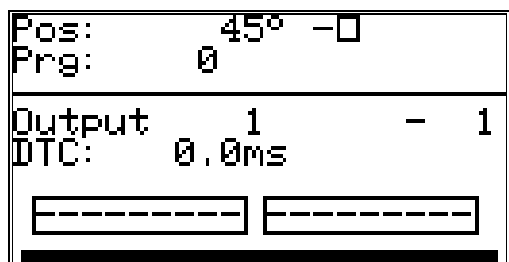

Solution:

1. Select the menu point "cam programming" in the main menu.
2. Enter your user code and press the **CR** key. The programming menu is displayed.

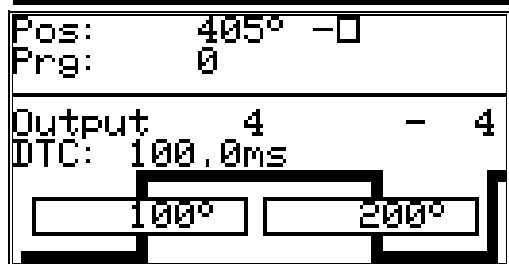

3. Select output 4 with the **▲** key or press **CR**, enter "4" and press the **CR** key again.

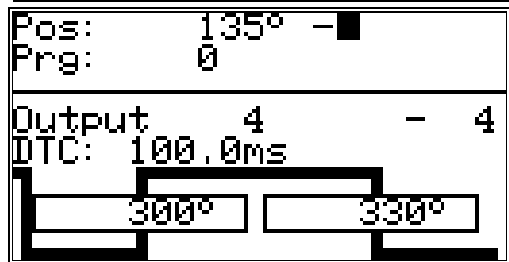



4. Select the inserted cam with the **▶** key.



5. Press the **DEL** key. The display shows the following question:

6. Using the **◀** key, move the cursor to "yes".
7. Press the **CR** key to confirm your input. The cam between 300° and 330° is erased.

7.3.18. Programming analog cams

If your CamCon is equipped with analog outputs, and you have activated the option of analog cams (see chapter "7.4.5.3.2. Configuration of the analog cams" on page 63), the last "normal" output will be displayed as the first analog output after pressing the . If several analog outputs are programmed, you can choose the next output number by pressing the  key.

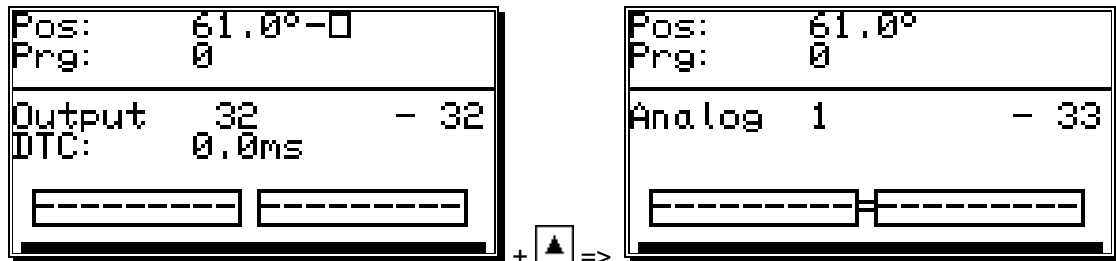

The output numbers of the analog cam outputs are always added to the numbers of "normal" outputs and this number can be selected directly from the programming menu. If you have configured e.g. 32 cam outputs, the number of the first analog cam starts at the output 33. The output number of the analog cam changes automatically when you change the number of "normal" outputs (see chapter "7.4.6.2. Setting the outputs" on page 65).

The programming of the analog cam is **mostly** done as described in the chapters for "normal" cam programming (see chapter "7.3. Cam programming"). For analog outputs, you do not program a position as a deactivation point, but an analog value. If several such values are programmed at different positions and the measuring system starts to move, CamCon controls the analog output in such a fashion, that a curve is done, corresponding with the drawing below.

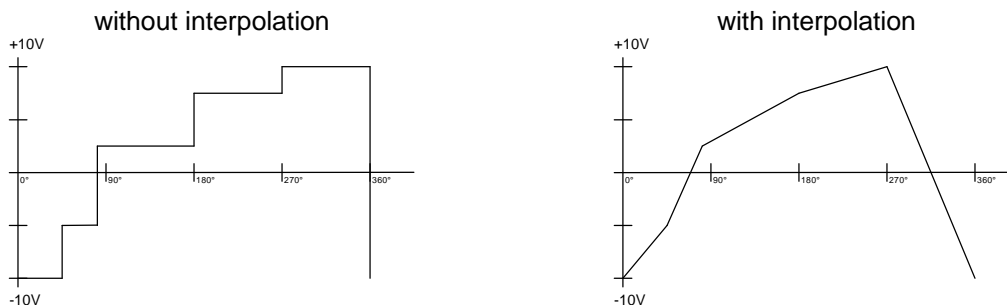

Through interpolation of the definition points, CamCon can adjust the values and present a curve, corresponding to the above right drawing.

7.3.18.1. Creating the first analog cam

To program your first analog cam, choose the program and the desired output for programming (see chapters: "7.3.2. Program selection for programming" and "7.3.1. Output selection for programming"). Press the $\boxed{\downarrow}$ key and enter the position value for the first definition point. Now press the \boxed{CR} , enter the analog value and confirm your input with the \boxed{CR} key.

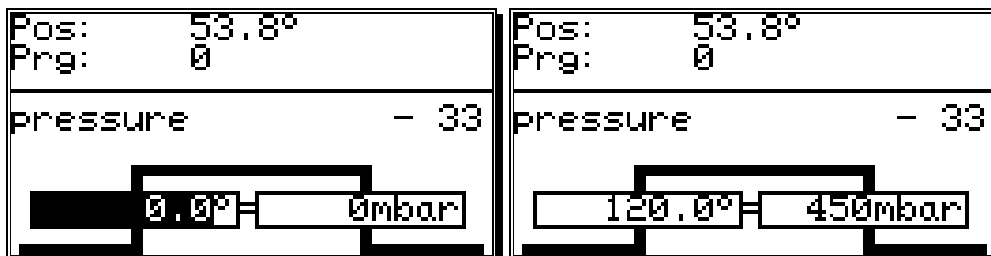

Note: As long as only one cam is programmed on a cam track, the programmed analog value is emitted for the whole way of the measuring system.

7.3.18.2. Adding an analog cam

To add another definition point, choose a desired output, press the \boxed{INS} key and enter a new position value. Press the key \boxed{CR} , enter the analog value and confirm your input with the \boxed{CR} key.

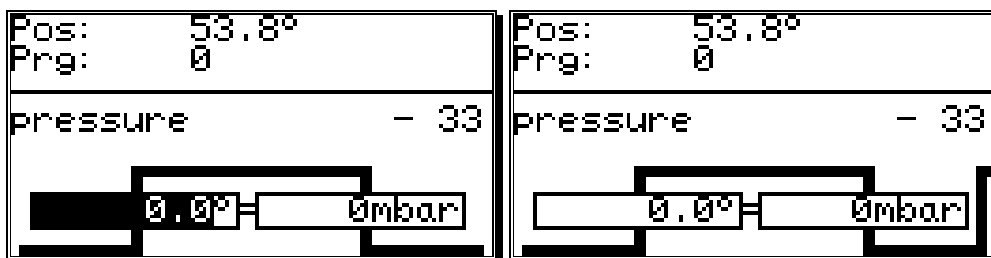

Further cams are added with the same procedure.

7.3.18.3. Changing the analog cam

To change or delete an analog cam, proceed as described in chapters "7.3.10. Cam Search", "7.3.11. Cam deletion" and "7.3.12. Output (cam track) deletion".

Note: The programming of a delay time, the copying of an analog cam track and the shifting of the complete cam track is not possible at the time.

7.4. Unit configuration (system setting)

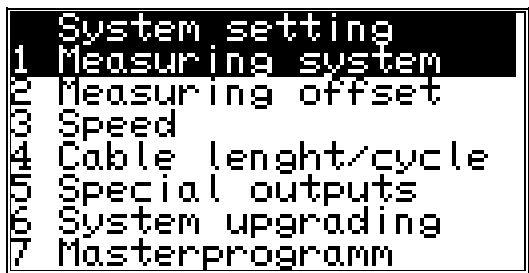

Before you are able to use this device, you have to give it all the information about the parameters of your measuring system. Select the menu point "**System setting**" in the main menu. The display shows the system setting menu:

7.4.1. Measuring system

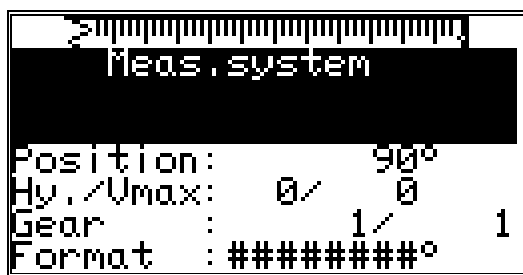

When you select the menu point "**Measuring system**", the display changes to the measuring system menu:

Here you can configure the measuring system, the resolution, the electronic gear, the actual position hysteresis, the rotation direction and the display format of the actual position, as well as a special measuring system. Additionally, the menu point "**Position:**" always shows the actual position of the CamCon. See also chapter "4.2. The measuring system" on page 21.

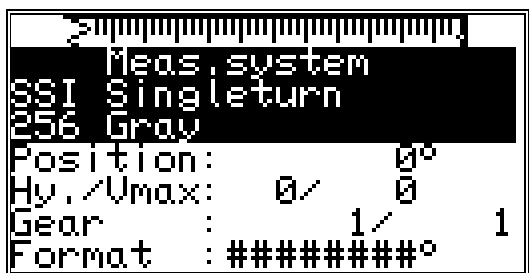

7.4.1.1. The standard measuring systems



The display gives the resolution of the measuring system in steps per rotation. Generally the CamCon works with a rotation angle coder that has a resolution of 360 steps per rotation. In this case a change in the input value is superfluous. Otherwise the CamCon can be adjusted to the measuring system with the  and  keys. You can choose between the following predefined resolutions, that are all in accordance with common rotation encoders: 256, 360, 512, 1000, 1024,

2048, 4096 and 8192 steps. Should you not be able to set values in higher resolution ranges, it is because there is not enough memory available. If this is the case you have to extend the memory of the device. Also, you can configure two analog SSI changer modules, AWA/SSI/8 and AWA/SSI/12, for the gathering of analog signals. These modules are connected to the SSI port of the CamCon.

Note: Should you not be able to set values in higher resolution ranges, it is because there is not enough memory available. You will need to upgrade the memory of your device. See also chapter "12. Calculation the RAM storage-requirement for" on page 88.

7.4.1.2. The actual position hysteresis

At the menu point "**Hyst.**" you enter the actual position hysteresis.

This value is needed to suppress the flashing of the outputs during uneven data gathering. The exact value can only be determined through experiments, though it should be as small as possible or always "0". The hysteresis can be between 0 and 1/4th of the total resolution, but can never exceed 255 impulses.

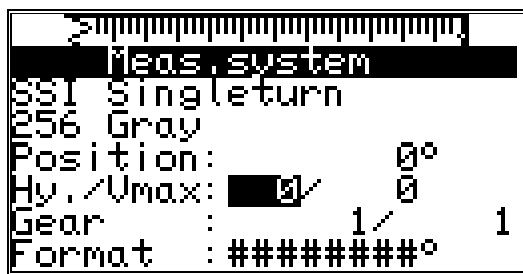

7.4.1.3. Controlling the measuring system

The option "Vmax" of the menu enables entering the tolerated steps per cycle of the actual value.. This enables controlling a measure-system.

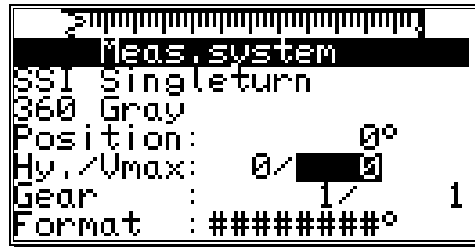

The required value is calculated of the CamCon's actual cycle-time, the measuring system's physical resolution and the device's Speed.

Note: The resolution needs to be a physical measure, e.g. if for a measuring system 4096 Impulses are calculated to 3600 by a (3600/4096)gear, the resolution must be set to 4096.

Example: Cycle time = 0.5ms / resolution = 360 / speed of machine = 180 min⁻¹.

$$\text{Value} = \frac{\text{resolution} * \text{plant speed}}{60 * 1000} * \text{Cycle time} + \text{margin}$$

$$\frac{360 * 180}{60 * 1000} * 0.5 + 5 = 5.54 \approx 6$$

The result is rounded and filled in "**Vmax**"

If the CamCon detects a step of more than 6 impulses at the actual value an error report "**Ist-Err:5**" is shown.

If a zero is filled in here, the controll is deactivated, and a maximum of 9999 is possible.

7.4.1.4. The electronic gear

In the menu point "**Measuring system**" a factor for a measuring range transformation can be entered. Through this the physical measuring range e.g. of a rotation encoder is transformed into a new, for the user effective visible measuring range. Generally this transformation has the relation 1:1. The first value represents the multiplier of the actual position, while the second value stands for the divisor through which the result of the previous multiplication is divided. The result of this operation is the display value. A negative value in the field of the multiplier changes the direction of the rotation of the measuring system. To switch the algebraic sign press the \pm key during the input of the multiplier.

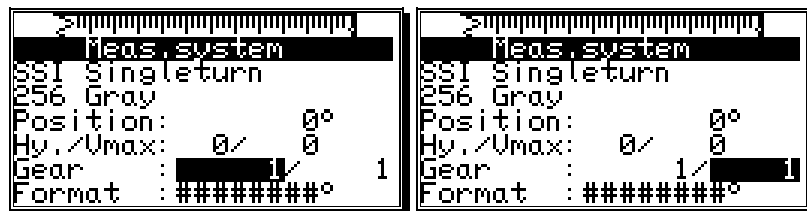

Example: At a full rotation of a rotation encoder with 360 steps per rotation a machine proceeds for 1000mm. If the display of the position is to be shown in mm rather than in angular lines, you have to reset the gear with the factor **1000 / 360**. The display will no longer change in single steps, since the resolution remains unaffected. If you choose e.g. **100 / 360**, the actual position is calculated down to a proceeding range of 100. The position display is carried out in cm, but a floating point representation is not possible.

7.4.1.4.1. Electronically changing the rotation direction

The direction of the rotation of the measuring system is set at the multiplier of the electronic gear by changing its algebraic sign. Press the \pm key during the input of the multiplier. See the chapter "7.4.1.4. The electronic gear".

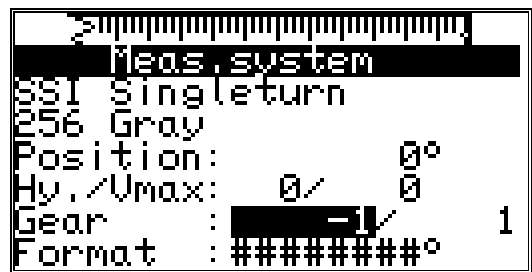

7.4.1.5. The display format of the actual position

In this menu point you can set the format for the display of the actual position.

The three # are the place holders for the number value of the display. You can enter additional comments and the unit of the measured value, e.g. mm, cm or inch with linear systems. See chapter "5.8. Text input" on page 28. If you want to display a decimal point, you can insert one between the place holders (e.g.: ###.#mm).

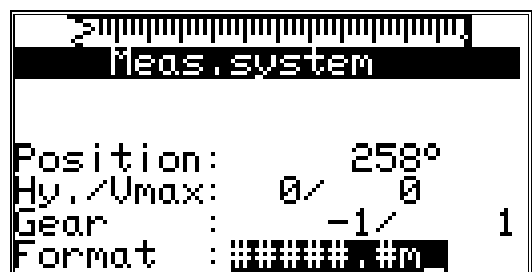

7.4.1.6. Configuration of a special measuring system

You have the possibility with CamCon to configure a special measuring system, according to the following steps:

1. To configure the special measuring system press the **INS** key. The menu for the input of a new measuring system appears on the the display.
2. Enter the measuring system description. See chapter "5.8. Text input" on page 28.
3. Presss the **CR** key to end the input of the first line. The cursor moves to the next line.
4. Enter additional text (if desired).
5. Press the **CR** key to end the text input. The cursor moves to the next menu point, "**Measuring system**".
6. Select the type of the measuring system with the **←** and **→** keys.
7. Press the **CR** key to confirm your input. Now the menu for the measuring system chosen by you is created. The following chapters discribe the different measuring systems and their settings.

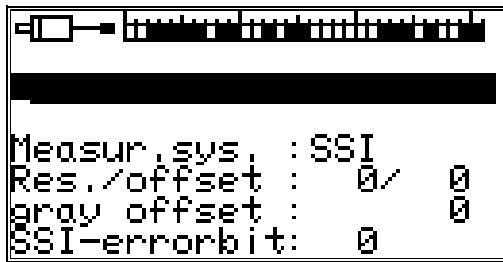

7.4.1.6.1. SSI - measuring system

If you selected "**SSI**" for your special measuring system in the measuring system input, the following menu is created:

1. Enter the bit number of the resolution of the SSI measuring system
A resolution of e.g. 500 impulses corresponds with 9 bits.
2. Now enter the position of the lowest-situated bit (LSB).
In our example the LSB would be on 9th position. You can get more specific information from the manufacturer of your measuring system.
3. Now enter the cut of the measuring system code.
In our example this would be $(512 - 500) / 2 = 6$.
4. Finally you have to enter the position of the SSI - errorbit of the measuring system. With standard rotation encoders of the firm Stegmann this position is 14. Always transfer a 0 to this position.
5. Press the **CR** key to confirm your inputs and exit this menu.

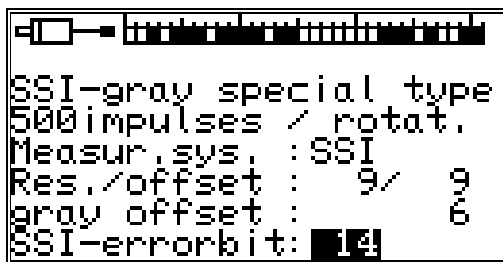

Attention: *The position of the data bits can be seen in the graphic in the upper part of the display. You can determine the positions of the LSB, HSB and errorbits quite easily by moving the measuring system.*

7.4.1.6.2. Parallel - Gray measuring system

If you selected "PARAL." for your special measuring system in the measuring system input, the following menu is created:



1. Enter the resolution of the parallel gray measuring system.
Here e.g. 500 impulses.
2. Now declare the input of the lowest-situated bit (LSB).

In our example the position of the LSB would be at input 7. With a resolution of 500 impulses 9 bits of resolution are needed. The CamCon automatically determines the position of the remaining inputs once it knows the position of the LSB; they are determined in increasing order. In our example inputs 7 to 16 would be allocated with the bits of the rotation encoder.

3. With **Mode** you can choose the encoding of an parallel measure system by pressing and : you can choose between **Gray** = Gracode and **Bin.** = Binarycode zur Verfügung.

Attention: Parallel binary encodings shall only be used as an exception. Please implicitly contact your custoimers service.

4. Press the key to confirm your inputs and exit this menu.

7.4.1.6.3. Incremental - measuring system

If you selected "INC" for your special measuring system in the measuring system input, the following menu is created:

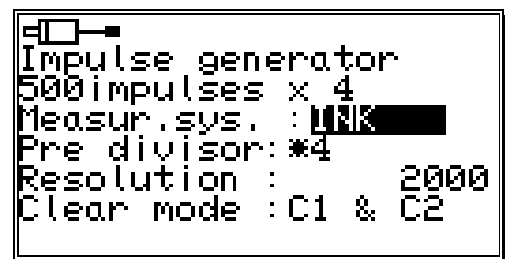

1. Enter the value of the prescaler (predivisor) with the and keys. The prescaler divides or multiplies the incoming impulses from the measuring system with the defined value. The following scalers can be entered: "*4", "*2", "*1", "/2", "/4", "/8", "/16", "/32", "/64", "/128", "/256", "/512".

Here the prescaler is set to "*4". This means that a measuring system with a resolution of 500 impulses supplies the device with 2000 impulses.

2. Now you enter in the field of the resolution the maximum number of needed impulses. This value is the maximum resolution, that can be evaluated by the CamCon. If more impulses than this maximum resolution are counted, the CamCon reports the error message "Pos Err:3". In this case the maximum resolution has to be reset with a higher value or the actual position has to be set to zero through a clear signal.

3. In the field "**Clear mode**" you set the functions for the two extra inputs C1 and C2 with the and the key. Here you have the choice between eight possible functions.

"C1 & C2"	If input C1 is high and C2 is high, the counter is set to zero.
"/C1 & C2"	If input C1 is low and C2 is high, the counter is set to zero.
"C1 & /C2"	If input C1 is high and C2 is low, the counter is set to zero.
"/C1 & /C2"	If input C1 is low and C2 is low, the counter is set to zero.
"C1 : W"	If input C1 is high, the counter is set to zero.
"/C1 : W"	If input C2 is high, the impulses of the measuring system are no longer counted.
"C1 : /W"	If input C1 is low, the counter is set to zero.
"/C1 : /W"	If input C2 is high, the impulses of the measuring system are no longer counted.
"C1 : W"	If input C1 is high, the counter is set to zero.
"/C1 : W"	If input C2 is low, the impulses of the measuring system are no longer counted.
"C1 : /W"	If input C1 is low, the counter is set to zero.
"/C1 : /W"	If input C2 is low, the impulses of the measuring system are no longer counted (W = Wait).

"C1 or $\bar{a}C2$ " Counter is set to 0, If input C1 is high or a signal at input C2 changes from low to high.

"C1 or $\bar{a}C2$ ". Counter is set to 0, If input C1 is high or a signal at input C2 changes from high to low.

7.4.1.6.4. Multiturn measuring system with electronic gear

If you selected "MULTI" for your special measuring system in the measuring system input, the following menu is created:

This measuring system is needed when using a multiturn encoder with a non-binary number of rotations.

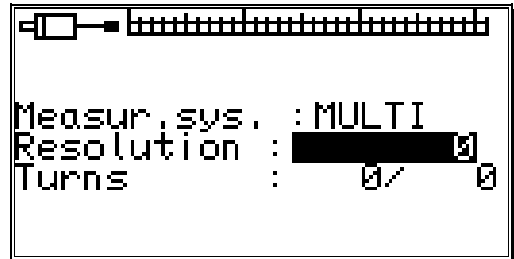

Example 1: You have a rotation plate with an electronic gear rate of 3 to 1, i.e. the encoder rotates 3 times for every rotation of the plate. These three rotations correspond with 360 impulses (360 degrees). You need to make the following inputs:

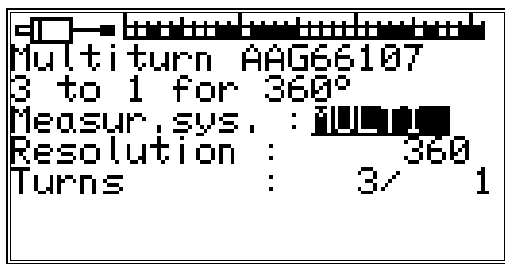

1. Enter the total resolution needed.
Here 360 impulses (360 degrees).
2. Enter the total number of rotations.
Here 3 turns.
3. Enter the divisor for uneven translation rates.
Here 1.
4. Press the key to confirm your inputs and leave the menu.

Example 2: You have a rotation plate with an electronic gear rate of 12.5 to 1, whereas the encoder turns 12.5 times for every rotation of the plate. These 12.5 rotations correspond with 3600 impulses (360.0 degrees). The following inputs are necessary:

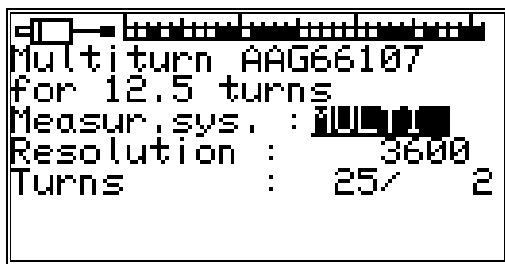

1. Enter the total resolution needed.
Here 3600 impulses (360.0 degrees).
2. Enter the total number of rotations.
Here 25 turns.
3. Enter the divisor for uneven translation rates.
Here 2.
4. Press the key to confirm your inputs and leave the menu.

Attention: This measuring system only works in connection with multiturn encoders with a resolution of 4096 x 4096 impulses (Type: AAG66107 or AAG626).

Note: With this measuring system the encoder may not be moved more than 512 rotations in a cold state.

7.4.1.6.5. PLL measuring system

If you selected "PLL" for your special measuring system in the measuring system input, the following menu is created:

The PLL measuring system determines the way out of temporal interpolation of a measuring impulse. If you e.g. have installed an initiator on a rotation plate and want to determine the current position at a constant velocity without having to install another measuring system, the PLL measuring system is the right choice.

```

┌───┐
│ PLL measuring system          │
│ 5 initiators 360°           │
│ Measur.sys. : PLL           │
│ Impulse/in.: 360/ 15        │
│ Init./c-inp: 10/ 16        │
│ Window/outp: 100/ 1        │
└───┘

```

1. Enter the number of steps from initiator impulse to initiator impulse.
2. Now enter the input of the initiator impulse.
3. Now you have to enter the number of initiator impulses per total rotation.
4. Select the input for the clear impulse.
With the PLL measuring system you have the possibility to incase several initiators per total rotation. To receive a zero point you need a zero initiator that can be hooked up to the selected input. If you do not want to use a zero initiator, just enter a "0" here.
5. Then you enter the synchronous window.
If a step error is determined that is larger than the set value, the system enters the asynchronous mode.
6. Now you have to enter the output for the synchronous window that signalizes the synchronous state. If you do not want such an output, just enter a "0" in this line. This output becomes active after the PLL measuring system has been in the synchronous mode for 16 cycles.

Press the key to confirm your inputs and exit this menu.

7.4.1.6.6. Timer way simulation (time emitter)

The timer way simulation makes it possible to generate ways (or time related actual positions) time based and without the use of a measuring system. The cam switch unit then behaves similar to the control of a washing machine. For this option you have to select "TIMER" in the special measuring system menu and the following system is set up:

```

┌───┐
│ Timer                         │
│ 100 impulses in 2 sec        │
│ Measur.sys. : TIMER         │
│ Impulsetime: 0.020          │
│ Resolution : 100            │
│ Stop-input : 1              │
│ Clear-input: 2              │
└───┘

```





1. First enter the time between the steps. The finest resolution of the CamCon is 1ms.
In our example we chose 20 ms.
2. Now enter the total number of steps.
We chose 100 steps for our example, so the whole process will be repeated after 2 seconds (20 ms x 100 steps = 2 seconds).
3. After this you have to enter the input for the stop signal.
This will enable the time emitter system. A high signal at this input releases the timer, and the timer is stopped by a low signal. If you do not want a stop input just enter a "0".
4. Finally you have to enter the input for the clear signal.
With this signal the time emitter system can be reset to 0. A high signal at this output causes the timer to remain at "0". If you do not want a clear input, just enter a "0" in the corresponding line.
5. Press the key to confirm your inputs and exit this menu.

7.4.1.6.7. RS232 measuring system

The RS232 way gathering is needed, if the measuring system used by you does not contain any of the interfaces described in the previous chapters.

To use this system you have to select "RS232" in the special measuring system menu and the following menu is set up:

```
RS232 way gathering
with Stegmann Pomux
Measur. sys. : RS232
Baud rate: 19200, 8, n, 1
Comm. prot: POMUX203BCD
Resolut. : 0
Pre divis: 0
```

1. First you have to enter the baud rate using the  and  keys.
2. The data transfer protocol can be set with the  key and the  key as before. At the moment only the data transfer protocol of a Stegmann Pomux 203BCD is available.
3. The resolution gives the value in which the actual position of the measuring system is moving.
4. The prescaler (predivisor) divides the resolution to enable the setting of the measuring system in devices with lower memory.
5. Press the  key to confirm your inputs and exit this menu.



Attention: This measuring system may only be used on a CamCon DC50/51, since it blocks the serial interface, making the programming via a PC or a terminal impossible!

7.4.1.6.8. AG615 - Single - Multiturn - Measuring system

Having selected "AG615" in the special measuring system-menu, the following menu appears.

The AG615 - Single - Multiturn - measuring system creates a multiturn- i.e. utility measuring system out of an AAG615 - 8192 Singleturn - measuring system.

As a result several rotations i.e, turns at the Single - Multiturn - Measuring system CamCon per rotation of the AG615 appear.

```
AG615-8192
Single-Multi
Measur. sys. : AG615
Resolution : 3* 360
```

1. Give in the number of rotations i.e. turns that shall be created at the CamCon first (e.g. 3).
2. Then enter the resolution that the CamCon shall display or process per turn (e.g. 360).
3. Confirm your inputs using the  key and leave the menu.

Example: For a value of 3 * 360 the CamCon will count thrice from 0 to 359 if the AAG615 encoder does one rotation along the shaft.

7.4.1.6.9. SIM - measuring system simulator

Having selected "SIM" in the measuring system menu, the following menu appears:

```

Encoder Simulator
SIM 8192
Measur.sys. : SIM
Impulses/s : 16384
Resolution : 8192
Stop-input : 0
Clear-input : 0
    
```

The SIM - measuring system - simulator enables creating ways or time actual values without measuring system, i.e. on time-basis. On the contrary to timer - measuring systems a higher speed is possible.

1. First enter the speed i.e. number of impulses per second (e.g. 16384).
2. Now enter the complete number of steps (e.g. 8192).
3. Now select an input for the "Stop" signal.
Thereby, the simulator may be enabled. A high signal at this input sets the simulator to run, a low signal stops the simulator. If you do not want an Stop - input, simply enter a "0" here.
4. Finally enter the clear signal's input.
With this function, you are able to enable the simulator. A "high" signal at this input leaves the simulator at "0". If you do not want a clear-input, simply enter a "0" here.
5. Use the CR key to confirm your inputs and leave the menu.

Example: With a resolution of 8192 and a speed of 16384 impulses per second a simulated speed of 120 revolutions per minute is set.

7.4.1.6.10. HIPER i.e. incremental - measuring system with Roll - Over - funktion

Having selected "HIPER" in the measuring system menu, the following menu appears.

```

Inkremental HIPER
Measur.sys. : HIPER
Pre Multipl: 5
Pre divisor: 7
Resolution : 360
Clear mode : C1 & C2
    
```



This special measuring system is used if the CamCon is equipped with an incremental measuring system input and an odd resolution of a gear would cause an adding measuring failure.

1. Enter the gear relation first by the multiplier and divisor (e.g. 5 / 7).
Note: Every change of edges is counted = quadruplication
2. Now enter the total number of steps i.e. increments that can be counted by the CamCon (e.g. 360). If more impulses are counted than set as resolution here, the CamCon restarts counting at zero. If the movement measuring system was set to "linear" at the menu configuration way, the CamCon switches to "Clear...". In this case the resolution has to be set greater or the actual value is set to zero, setting a clear signal.
3. In the filed "**Clear mode**" you can set the functions of the additional inputs C1 and C2 using the keys ◀ and ▶. You can choose between 8 different types of functions: "C1 & C2", "/C1 & C2", "C1 & /C2", "/C1 & /C2", "C1 : W", "/C1 : W", "C1 or \hat{a} C2" and "C1 or \hat{a} C2". See also chapter "7.4.1.6.3. Incremental - measuring system" on page 50.
4. Use the CR key to confirm your inputs and leave the menu.

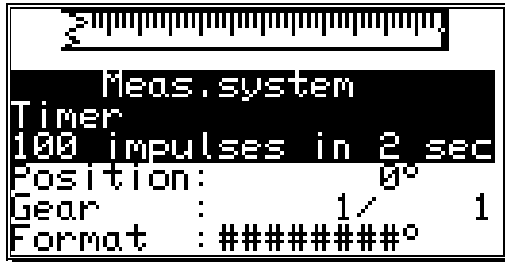

7.4.1.7. Deleting the special measuring system

The special configuration of the measuring system can be removed as follows:

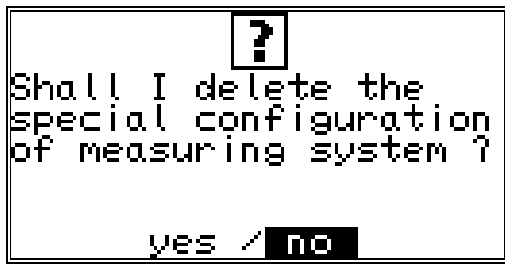

1. Select the menu point "**Measuring system**" in the configuration menu. The following menu is displayed:
2. Select the special measuring system with the  and  keys.
3. Press the  key, and the following question is displayed:





4. Move the cursor to "**yes**" with the  key and confirm your choice by pressing the  key.

This deletes all settings of the special measuring system.

7.4.2. The measuring offset

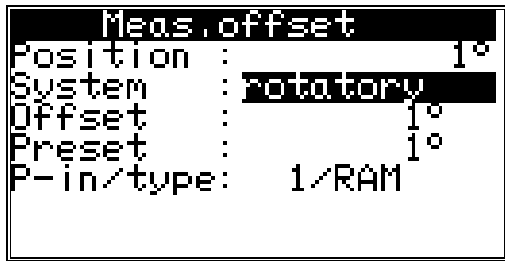
If you selected the menupoint "**Measuring offset**" in the system setting menu, the measuring offset menu appears on the menu:



Here you can indicate, using the  and  keys, whether your controlling system is a rotatory (e.g. an eccentric press) or a linear (e.g. a knee lever press) moved system.

You confirm your input with the  key.

7.4.2.1. Zero offset with rotatory movements

If you have chosen a rotatory movement, you can now carry out the input of the offset

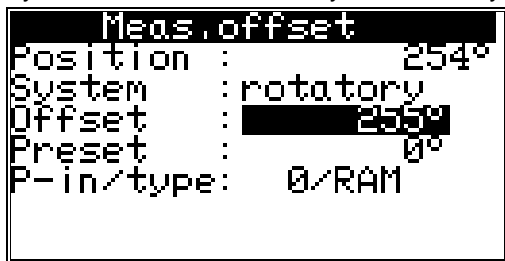

The offset is subtracted from the physical position. This makes it possible for you to shift the zero point.

7.4.2.2. Measuring offset with a linear moved system

If you have chosen a linear movement, you can now carry out the input of the moving range and the offset.

At the menu point "**Start**" you enter the desired begin of the proceeding range. You even have the possibility to enter negative values.

The "**End**" value of the measuring range changes automatically and determines the total proceeding way of the measuring system with its position. Here an input is not possible.

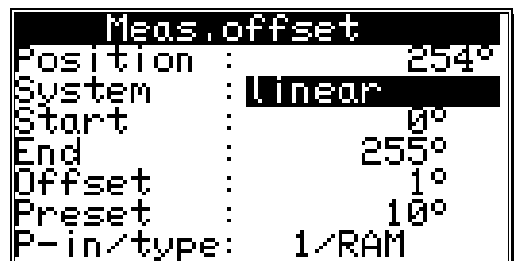

Attention: If the range between start value and end value is under- or overshoot during the way gathering of the measuring system, the CamCon switches off with the error message "**Pos.Err 3**".

7.4.2.3. Zero offset with linear movements

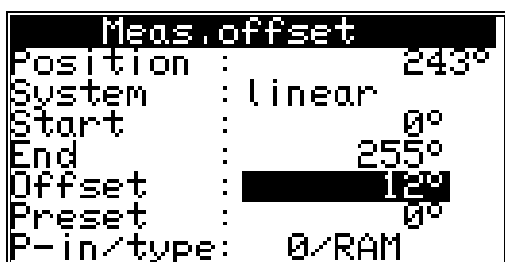

If you have chosen a linear movement, you can now carry out the input of the offset.

In the menu point "**Offset**" you enter the zero offset of the measuring system. The offset is subtracted from the physical position. This makes it possible for you to shift the zero point.

Note: If the rotation direction of the electronic gear is negative, the offset must be set to a value smaller than zero (e.g. -359). See chapter "7.4.1.4.1. Electronically changing the rotation direction" on page 48.

7.4.2.4. Actual position preset

In the measuring offset menu you have the possibility with the rotary system and the linear system to set the actual position to a new value by creating a new input (preset).

By setting the preset value to zero, you can generate an external zero signal, e.g. to synchronize the cycle of the machine and the actual position of the CamCon.

```

Meas.offset
Position : 243°
System   : linear
Start    : 0°
End      : 255°
Offset   : 12°
Preset   : 13°
P-in/type: 0/RAM
    
```

When you have entered the preset value, the device requests the input number of the preset signal with which the preset is supposed to be initiated. Enter the number next to the "P-In"-put line.

```

Meas.offset
Position : 243°
System   : linear
Start    : 0°
End      : 255°
Offset   : 12°
Preset   : 13°
P-in/type: 5/RAM
    
```

```

Meas.offset
Position : 243°
System   : linear
Start    : 0°
End      : 255°
Offset   : 12°
Preset   : 13°
P-in/type: 5/EEPROM
    
```

Afterwards select, using the keys and , the mode of storage of the preset value. Here you have two possibilities:

- "RAM" storage.

Here the preset value is copied into the RAM memory of the device. This means that after switching the device off and on again, the shifting of the actual position equals the zero offset or the offset is no longer available.

- "EEPROM" storage.

Here the shifting of the actual position is copied into the RAM and into the EEPROM memory of the device, making it safe to shut off the device without losing your data.

Attention: *You should only store your data in the EEPROM memory, if the triggering of the preset just occurs rarely and is absolutely required. This is because of the fact that an EEPROM only has a limited number of writing cycles: 100000). Shooting over this maximum number of writing cycles leads to the destruction of the EEPROM and the loss of the program data of the CamCon.*

Note: The preset input will be read in real-time since the software of the 21.5.2002. Therefore, a synchronisation of a device already running is impossible.

Pressing you can leave the menu.

7.4.3. The speed adjustment

If you selected the menu "Speed" in the system setting menu, the speed adjustment menu appears on the display:

You can use it to optimally adjust the speed of the device to the speed of the gear.

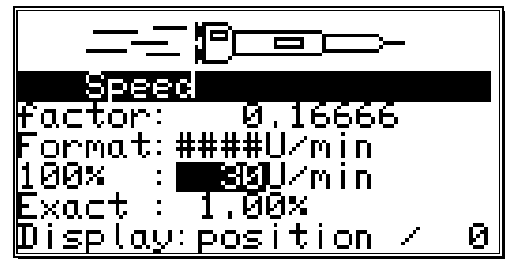

7.4.3.1. The speed factor

Normally the speed is displayed through the number of increments or impulses per second, an output of the measuring system. If you want the speed displayed e.g. in rotations per minute or in the number of pieces per minute, you have to enter a randomizing factor.

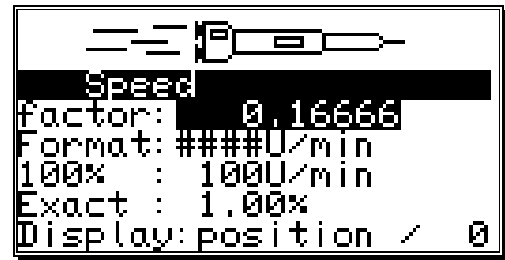

Example 1: A rotation encoder with 512 steps supplies 512 increments per minute, which means that the gear runs with 1 rotation per minute. The CamCon measures $512/60 = 8,533$ increments per second. To receive a display in rotations per minute enter the factor $1/8,533 = 0,1172$.

Example 2: A rotation encoder with 360 steps supplies 360 increments per minute, which means that the gear runs with 1 rotation per minute. The CamCon measures $360/60 = 6$ increments per second. Enter a factor of $1/6 = 0,16666$ to have the display remain in rotations per second.

Note: The speed factor is influenced by inputs in an electronic gear. Also see chapter "7.4.1.4. The electronic gear" on page 48.

7.4.3.2. The display format of the speed display

When you have adjusted the speed range with the factor, you can enter the presentation format of the display, using the and keys (see chapter "5.8. Text input" on page 28).

The # symbols are place holders for the displayed value. If e.g. the highest value is lower than 1000 and only has three digits, you only enter three # symbols. If you want a decimal point displayed, just insert it between the symbols (e.g. : ###.##). Press the key, and the cursor moves to the next menu point.



7.4.3.3. Range adjustment of the speed display

In this menu point you enter the maximum speed of your gear or the speed of your movement. This input is used to adjust the speed display.

An input of e.g. 1000 rotations per minute means that at +/-1000 rotations per minute the maximum analog output voltage, (100%) +/-10V, is reached.

This scale also applies to the speed bar that is shown in the middle of the standard display. Its length is the current speed compared to the entered reference speed in percent. Furthermore this is the point of the speed where the standard display switches from the position to the current speed. This point always lies at 5% of the here entered value, for 1000 rotations per minute it lies at 50 rotations per minute.

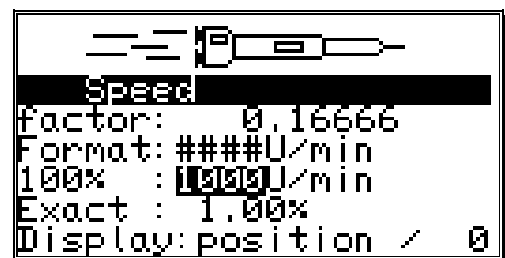

7.4.3.4. Accuracy of the speed display

During operations the speed display usually fluctuates by a certain value. These fluctuations are accounted for in the measuring principle for the speed, since it is a scanning system.

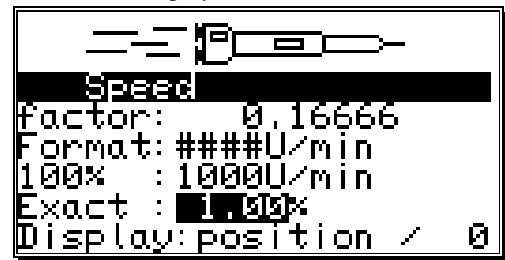

In the menu point "**Exact**" you can limit these fluctuations to a maximum value. It is a damping through a low pass that results in a smoothing of the display, which means that an averaging process is put into operation. The lower the input value is, the quieter is the speed display. In practice, you will always find a compromise between the dynamics of the display and its readability.

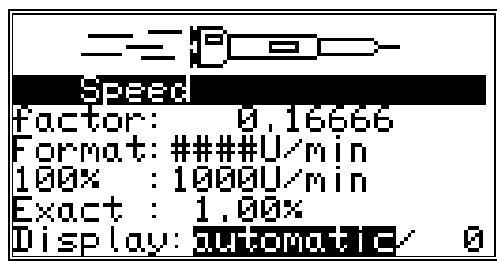

Note: The "**Exact**" value also corresponds to the speed value, which is provided by an CP16 or CamCon DC115 of an PLC.

7.4.3.5. Display, Type



If you want to prevent the automatic switching at the 5% of the maximum speed in the "**Display**" menu point, you can select one of the three different display types with the  key and the  key.

- "**Automatic**" At the 5% point the display is switched from the position display to the speed display. This bar display shows the speed in percent.
- "**Speed**" Only the speed is shown on the display. The bar display shows the speed in percent.
- "**Position**" Only the position is shown on the display. The bar display does not show the speed, but it displays the position between 0% and 100% e.g. 0% = 0 Degree / 50% = 180 Degrees / 99% = 359 Degrees.

In addition to the three display types, you can also select the desired display type through an input. The display type has to be set to either "**Speed**" or "**Position**", and the number of the input has to be entered in the field behind. When input is passive, the set display type is displayed. When you supply a signal, the display changes from "speed" to position or from "position" to "speed".

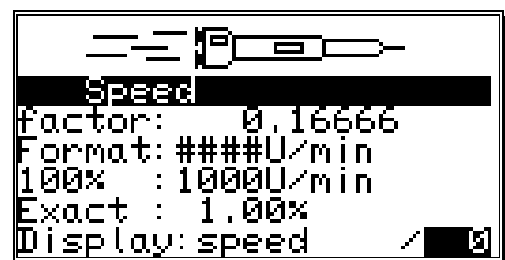

Press the  key to confirm your inputs and exit this menu.

7.4.4. Cable length / Cycle time

If you selected the menu "Cable length/Cycle time" in the system setting menu, the following menu is set up on the display:

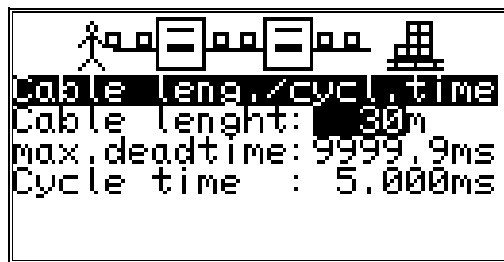

7.4.4.1. The cable length

In this menu point you can set the conduction length between the SSI measuring system and the CamCon, as well as between external input or output extensions and the CamCon, in meters. This is necessary, since the cable length determines the maximum possible speed of serial data transmission. The larger the set cable length, the larger is the cycle time of the transmission and the slower is the data traffic. The cable length can be set to a maximum of 1000m.

Attention!! With cables exceeding 300m in length use a corresponding measuring system as well as extensions with a changed mono-flop-time.

7.4.4.2. The cycle time of the CamCon

Normally the CamCon operates with the shortest possible cycle time. It is displayed as long as the cursor is not on the menu field "Cycle time". With an input in the menu field "Cycle time" this time value can be changed.

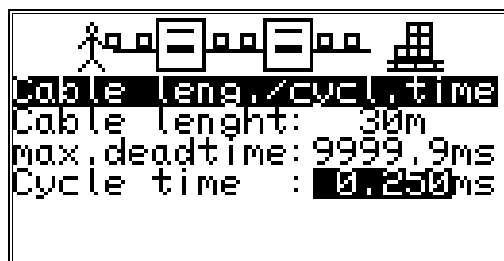

This might become necessary, if e.g.:

- you are programming a large number of outputs with delay time or with a high measuring system resolution and need longer single delay times. These depend on the available memory and the cycle time (see chapter "12. Calculation the RAM storage-requirement for" on page 88). A noticeable change occurs only when the set value lies above the current cycle time. For this reason the display also shows the maximum possible speed compensation.
- you connect a measuring system that allows the readout of the data only once in a given time.

Press the **CR** key to end your input and exit the menu.

7.4.5. The special outputs

If you selected "**Special outputs**" in the system setting menu, the special outputs menu appears on the display:

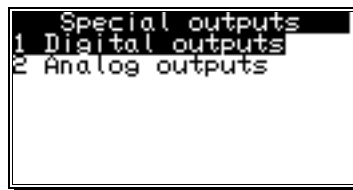

First you have to select if you need to configure a digital or analog output.

Menu for digital special output

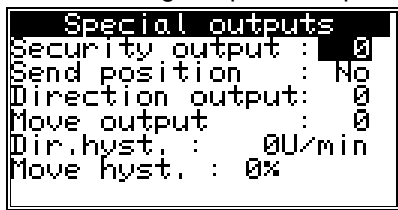

Menu for analog special output

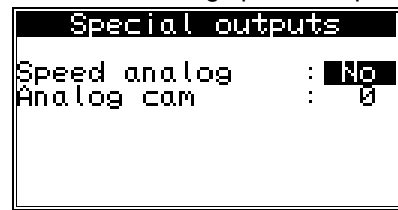

7.4.5.1. The digital special outputs

7.4.5.2. The security output



To have the possibility to supervise the CamCon e.g. after short circuits on the output channels or mistakes in the measuring system, you can program a circulation cam for a single output, so that this output is switched off at the occurrence of a mistake and serves as a security output. With a program change, the security output is reset for a short time (see chapter "7.4.6.9. Setting the program selection mode" on page 66).

A "0" in the input field defines that no security output has been programmed..

7.4.5.2.1. The output of the actual position

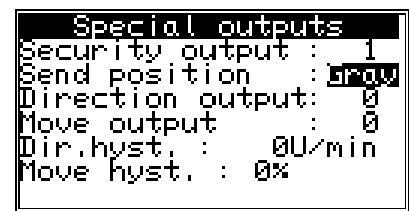
The CamCon offers the possibility to put the physical actual position out to outputs. It is used when several CamCon need the same actual position (Master Slave connection). To be able to use this option, the number of the programmed outputs has to be lower than the number of the actually available ones (see chapter "7.4.6.2. Setting the outputs" on page 65). The output of the bit with the lowest value will occur after the last programmed output. The other bits follow in increasing order.



With the  and  keys you can choose 4 possible output formats:

- "No" = No output of the actual position.
- "Gray" = Output of the actual position in the gray code.
- "Bin." = Output of the actual position in the binary code.
- "Exp." = Output of the actual position in the gray code only for CamCon DC115.

Confirm your input with the  key.

7.4.5.2.2. Direction output

To be able to recognize the direction of the movement of a machine with different movement directions, you can program an output that switches on at a positive and off at a negative movement.

```
Special outputs
Security output : 1
Send position  : Gray
Direction output: 2
Move output    : 0
Dir.hyst.     : 0U/min
Move hyst.    : 0%
```

7.4.5.2.3. The standstill output (Move output)

The CamCon offers the possibility of a standstill surveillance.

Here you can define an output that is switched on when the actual speed is greater than the at "Dir.hyst." entered value and that switches off when the speed drops below that value again.

```
Special outputs
Security output : 1
Send position  : Gray
Direction output: 2
Move output    : 31
Dir.hyst.     : 0U/min
Move hyst.    : 0%
```

7.4.5.2.4. The hysteresis

To be able to use the options of movement direction surveillance and standstill surveillance correctly, you have to set the hysteresis. This value is needed to suppress the jittering of the outputs at small changes in speed. This value can only be determined through experiments, but it should be as small as possible.

```
Special outputs
Security output : 1
Send position  : Gray
Direction output: 2
Move output    : 31
Dir.hyst.     : 5U/min
Move hyst.    : 0%
```

7.4.5.2.5. The Move hysteresis of the standstill output

New with the CamCon software version from 3/2006 you can enter a hysteresis for the switch point of the standstill output (Move output).

You can enter the value in percent of the "Dir.hyst" value from 0 upto 99%.

```
Special outputs
Security output : 1
Send position  : Gray
Direction output: 2
Move output    : 31
Dir.hyst.     : 5U/min
Move hyst.    : 10%
```

7.4.5.3. The analog special outputs



7.4.5.3.1. The analog speed output

```

Special outputs
Speed analog   : yes
Analog cam    : 0
    
```

CamCon emits a voltage (proportional to the speed) on the first analog output (pin 2 at CamCon DC50), 0 to -10V with a negative rotation direction and 0 to +10V with a positive rotation direction, if the menu point "**Speed Analog**" is set to "yes".

The output voltage reaches its maximum of 10V, when the 100% value, described in chapter "7.4.3. The speed adjustment", is surpassed.

You can deactivate this function by setting the menu point to "no" with keys  and , and confirming it with the  key.

Note: At the time, there are no integrated analog outputs available for CamCon DC16 and DC90. You can add analog outputs by connecting a CamCon DAC16 digital - analog - converter module to the external interface of the CamCon.

Note: To clear the integrated analog outputs please see chapter "7.5.3.3.1. Clearing the integrated analog outputs" on page 74.

7.4.5.3.2. Configuration of the analog cams



```

Special outputs
Speed analog   : Yes
Analog cam    : 2
    
```

With a CamCon cam controller you have the possibility to make an output of free programmable analog values (cams) dependent on the position. You enter the number of analog outputs in the menu point "**Analog cams**", that you want to program via the CamCon. In most cases, this will also be the number of your analog hardware outputs.

Note: If the menu point "**Speed Analog**" is set to "yes", the first analog output is used to display the speed, and the number of possible analog outputs is decreased by one.

When you enter the number and press the  key, you enter the input of the specific settings for the analog cams:

First you choose the number of the analog output with keys  and .

Press the  key to confirm the number and change the display to the input of the display format.

```

Analog outputs
No.           : 1
Format        : ####.##%
Minimum       : -100.00%
Maximum       : 100.00%
Dis.Input     : 0
Dis.Value     : -100.00%
Interpol.     : Yes
    
```

```

analog outputs
Nr.           : 1
Format        : ####.##%
Minimum       : -100.00%
Maximum       : 100.00%
Dis.Input     : 0
Dis.Wert      : -100.00%
Interpol.     : Yes
    
```

Here you enter your desired format, as described in chapter "5.8. Text input" on page 28. It is e.g. possible to make the input in percent "####.##%" (standard), in voltage "###.###V", in bar "#.###mbar" or in Ampere "##.###mA". The double-crosses are just placeholders for the real numerical values. The scaling of the input values is done in menu points "**Minimum**" and "**Maximum**".

```

analog outputs
Nr.      : 1
Format   : ##.####mA
Minimum  : 4.0000mA
Maximum  : 20.0000mA
Dis.Input : 0
Dis.Wert : 4.0000mA
Interpol. : Yes
    
```

When you confirm the format with the **CR**, you enter the input for the minimum value.

Note that CamCon always calculates with an accuracy of 16 Bit. The minimum value is the bit value 0 (e.g. -10V or 4mA) and the maximum value is the bit value 65535 (e.g.+10V or 20mA). The values should be entered according to the purpose of the device. If e.g. an CamCon DAC16/I module (current output) is connected to the

external display, the input can be made in milliampere, or the milliampere value corresponds to a physical pressure - or speed, this value can also be entered in bar or meters per second (see values in figure above).

Note: The integrated analog outputs of the CamCon DC40, 50 and 115 all work with an accuracy of 8 Bit. The output of the analog cam values is recalculated from 16 bit to 8 bit in this case.

After the minimum and maximum values have been confirmed with the **CR** key, the com inputs in the programming menu are restricted to the range between minimum and maximum and recalculated, if necessary.

The output of the analog value can be stopped by setting an input to a specific value. For this purpose enter the input number in the menu point "**Dis.inp.**" (Disable Input), with which the analog value is set to the "**Dis.val.**" (Disable Value). The "Dis.value" must be within the range of minimum and maximum. The "Dis.val." is automatically set as a default value, if no cam has been programmed on the analog output.

When the "Dis.val." is confirmed you can activate ("yes") or deactivate ("no") the interpolation of the analog value with the keys **◀** and **▶** in the menu point "**Interpol.**". If this value is set to "yes", CamCon interpolates the programmed values from definition point to definition point.

Example:

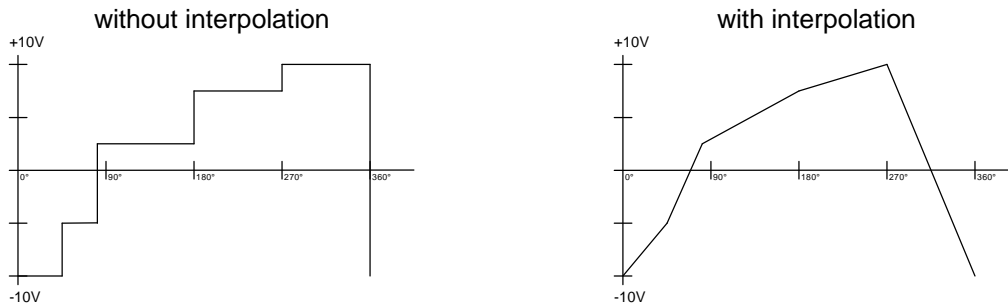

By pressing the **CR** key, the input of the interpolation is confirmed, and you move back to the selection of the number of the analog output. Here you can choose the number of the next analog output with the keys **◀** and **▶** and proceed with the input of the values as before.

When the input is finished, you can leave the menu by pressing the **ESC** key.

For the input of the cam values please see chapter "7.3.18. Programming analog cams" on page 44.

7.4.5.4. The analog position output

The analog position output of the CamCon can be programmed with a software version of at least DC50.20, by the input of an analog cam. Herefore you program an analog cam, that emits -10V at an actual position of 0 degrees and +10V at an actual position of 359 degrees (see chapter "7.3.18. Programming analog cams" on page 44).

7.4.6. System upgrading

If you selected the menupoint "**System upgrading**", the following menu appears on the display:

```

System upgr.
Inp.: 16  Outp: 32
DTC : 32 NLT: 0( 0)
K-lock-inp.: 0 EQ 0
Enable-input : 0
Prg.-select-Input: 1
NoP.: 2 Typ: on pos.
change at : 10
    
```

7.4.6.1. Setting the inputs

Here you can enter the number of inputs available to the CamCon. This number of inputs should always be exactly the same as the number of electrical inputs, since the short circuit detection of the CamCon reacts to the number of inputs.

7.4.6.2. Setting the outputs

Here you can enter the number of outputs available to the CamCon. This number of outputs should not be greater than the number of electrical outputs, since this only results in a waste of memory and cycle time. If you want to make an output of the actual position at the outputs, you have to decrease the number of outputs by the corresponding number of bits (see chapter "7.4.5.2.1. The output of the actual position" on page 61).

7.4.6.3. Setting the outputs with speed compensation

Here you can enter the number of outputs with speed compensation available for the CamCon. The number of outputs should not be greater than the maximum number of the absolute necessary outputs; otherwise only memory and cycle time are wasted.

7.4.6.4. Setting the Not - Linear - Speed compensation(NLT)

Here you have to enter the number of NLT tables you need. The maximal value is 246. Do not enter here more the necessary tables because each of the tables need memory and cycle time. The bracketed value shows you the number of given/used NLT tables.

7.4.6.5. Setting the keyboard lock

Assigning a +24VDC level to the programmed input pin will disable the keyboard. After this it is not possible to program or initialize the device any more. Resetting the value to "0" will enable the keyboard again.

7.4.6.6. Error - acknowledging Input (EQ)

A positive edge (+24V DC)at the inputnumber shown here leads to acknowledging an error-notice at the CamCon "Pos-Error": 1,2,3 and 5 **but not** an output error"

7.4.6.7. Input for enableing Outputs

A signal (+24V DC) at the input-number shown here enables Cam-outputs, an 0 signal locks Camoutputs. If this value is set to "0", the "enableing function is inactive and the Cam-outputs are permanently enabled.



Note: If a PLC-Logic-module is switched on, this effects rather the "0"-outputs but the Cam-outputs "N".

Note: Using a CamCon with direct PLC-attachement via CP16 or CP340 respective a CamCon DC300 and 1756-DICAM, these enableing-functions should be switched off (0), for the PLC-enableing-function takes on their function.

7.4.6.8. Setting the external program selection

With the CamCon you have the possibility to externally select the desired program number through the inputs. Here you enter the number of programs that can be selected externally, and this simultaneously predefines how many inputs will be used for this purpose. Then the input for the take over impulse is stated. The program number is created as a binary number at the inputs after the take over impulse. The bit with the lowest value is the input after the take over impulse, all others then follow it in an increasing order. Because of this the inputs for program selection are completely relocatable.. With an impulse (+24V) the program is selected at the input of the take over impulse. This impulse has to be created at least 20 ms after the program number and has to be at least 20 ms long.

7.4.6.9. Setting the program selection mode

You can change programs in several ways. Here you have the possibility to determine the desired way to change the programs with keys  and . You can select between:



- "**slow**" Here the selected program is built up cam after cam. This type of program changing requires the least memory, but a complete change of programs during a full run can lead to complication with the machine. In this case the security output of the CamCon is switched off for a short time.
- "**direct**" Here the selected program is built up cam after cam in an intermediate memory and changes the full program at once. This type of program changing requires the double amount of memory for the cam build up, but the outputs are always defined in every cycle. The security output of the CamCon will not be switched off in this case.
- "**on position**" The program is built up in the same way as in the "direct" type, but here the CamCon waits with the program change until the machine has passed a certain position and then makes a complete program change. This type of program changing also requires the double amount of memory for the cam build up, but the outputs are always defined in every cycle. The security output of the CamCon will not be switched off in this case.

7.4.7. Masterprogram

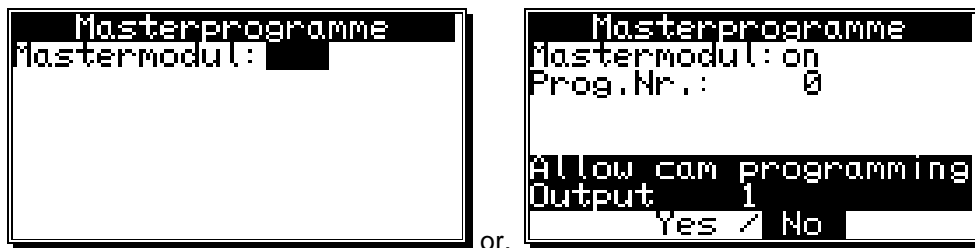
Having selected "Masterprogram" in the menu "system config" you will get to the following display.







Here you are able to define Cams for different products and programs. They could be necessary if your plant produces different types of products that have only very little differences concerning their Cam-adjustment. You are able to save a lot of storage for Cams (EE-Prom), because these mastercams do not need to be programmed multiple.

If you wish to use this funktion, at first the "Mastermodule" must be switched "on" using key , that has to be confirmed by pressing .

Now enter the masterprogramnumber by wich the Mastercams will be saved. You can use every programnumber from 0 to 32767.

Having confirmed the masterprogramnumber by pressing , you have to define which Output or Camtrack shall be used as Mastercam.



Here you can switch the outputs access to the masterprogram on (YES) or off (NO) by pressing  and . The keys  and  are used to select the favoured Outputmuber or Camtrack. Pressing  quits the input.

Example:

Having adjusted the masterprogramnumber 32767 on and switched output 1 on YES, a Cam in Program 32767 programed for output 1 will be also editet, if automaticprogram is set to 0. Cams in Programm 0 programed for output 1 will be ignored though.

To program a Mastercam, switch to menu "programming" and choose your favoured outputnumber. If you are not in the Masterprogram while putting in Cams, the system automatically switches to Masterprogram so that you can change a Mastercam.

Note: In putting in Cams in the "Programming"-menu the only possibility to change Mastercams, if your logged in with an user key, that has access to "System config". This disables a user at the plant to change MasterCams. The procedure of the plant can therefore only be changed by a person that has the essential access-key-code.

Note: If choosing the Masterprogram to program Cams, only MasterCams may be changed.

Note: If an automatic-program is set on the Masterprogram's number, only the Cams programed by Masterprogram will be put out.

7.5. Unit configuration

At the first activation of the CamCon, you should initiate a complete deletion and, if desired, allocate the user keys for associates. To do this, select the main menu point "**Unit configuration**". The display changes to display the configuration menu:

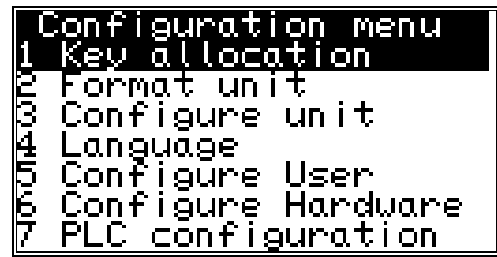

7.5.1. User key allocation

You can assign different user keys to your associates, each with different access rights.

Attention: *As long as no key is created, you can enter every menu with the key code "5693". When you create your first key, this master key is automatically deleted. If you forget to create at least **one** key that allows access to the configuration menu, you have locked yourself out of the configuration menu as soon as you leave it. This can be overcome by sending the unit back to Digitronic or with the entry of a special supervisor number. You can acquire this number with a phonecall to Digitronic Automationsanlagen.*









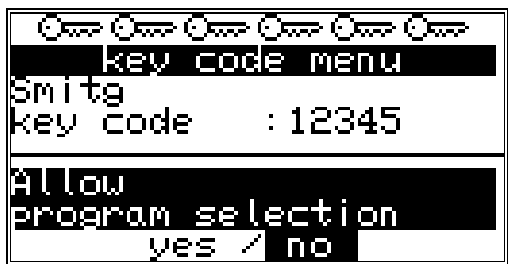
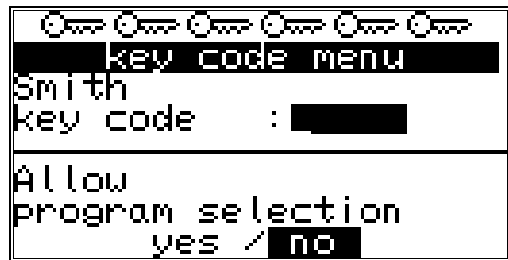
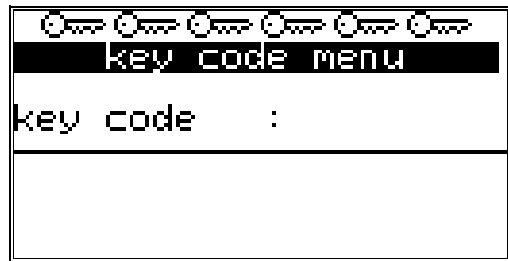



7.5.1.1. Creating a new user key



Follow these steps to create a new user key:

1. Select the menu point "**Key allocation**" in the configuration menu; the display changes to the key allocation menu:
2. Press the **INS** key, and the input field for the name is underlined in black.
3. Enter a name. See chapter "5.8. Text input" on page 28.
4. End the text input with the **CR** key, and the cursor moves to the input field "**Key number**".
5. Enter the key code with the numeric keys (up to 5 numbers).
6. Press the **CR** key. The cursor moves to the input field for the **access to the program selection**.





7. Choose between "**yes**" and "**no**" with keys **◀** and **▶**.
8. Press the **CR** key. The cursor moves to the input field for the **access to the cam programming**.
9. Choose between "**yes**" and "**no**" with keys **◀** and **▶**.
10. Press the **CR** key. The cursor moves to the input field for the **access to the system menu**.
11. Choose between "**yes**" and "**no**" with keys **◀** and **▶**.
12. Press the **CR** key. The cursor moves to the input field for the **access to the configuration menu**.

13. Choose between "yes" and "no" with keys  and .
14. Press the  key. The cursor moves to the input field for the **access to the outputs, generally and for every output**.
15. Choose between "yes" and "no" with keys  and .
16. Press the  key. If you chose "no" in the previous input field, you can now assign the access to each output one by one.
The cursor moves to the input field for the **access to output No. 1**.
17. Choose between "yes" and "no" with keys  and .
18. Press the  key. The cursor moves to the input field for the **access to output No. 2** and so on...
19. You can leave this menu at any time by using the  key.



Note: You can also select the menu fields for the single access rights with keys  and .

7.5.1.2. Deletion of a user key

You can delete a user key according to the following procedure:

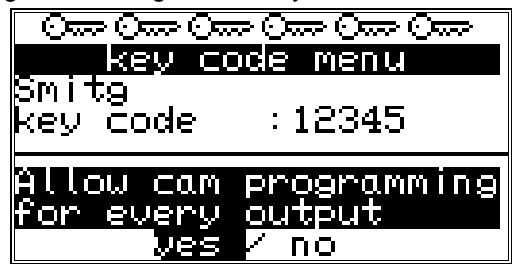
1. Select the menu point "Key allocation" in the configuration menu; the menu for the key allocation appears:
2. Select the user key you want to delete with keys  and .
3. Press the  key; the display shows the question:







4. Move the cursor to "yes" with the  key.
5. Press the  key, and the key is deleted.

Additionally: If you happen to delete every key in this menu, the standard key code "5693" is automatically generated.

7.5.1.3. Checking the key configuration

You can check an allocated key the following way:

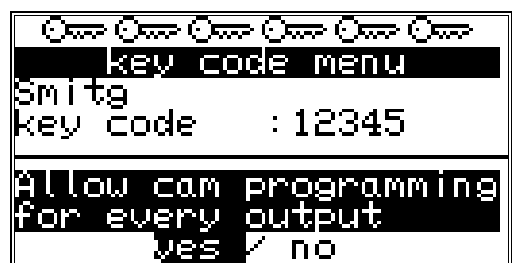

1. Choose the menu point "Key allocation" in the configuration menu; the menu for the key allocation appears:
2. Select the key that is to be checked with keys  and .
3. Now you can check the single access rights mit keys  and .

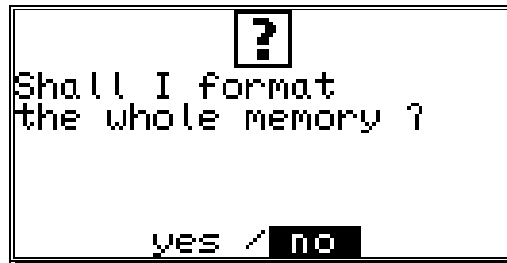

7.5.2. Complete deletion

If you selected the menu point "**Complete deletion**" in the "**Unit configuration**" menu, the display shows :



You can move the cursor to "**yes**" with the  key and confirm it with .

After a short while the display returns to the main menu. This time depends on the size of the EEPROM used, since the memory has to be formatted. Using e.g. a 32k EEPROM the process takes about 2 minutes. Afterwards, the complete deletion is complete. All cams are deleted, and the system registers have their standard values.

Now you can begin with the programming.





Attention:

Deleted information cannot be restored.

7.5.3. Unit configuration

If you selected the menu point "**Configure unit**" in the "**Unit configuration**" menu, configuration menu appears on the display:

7.5.3.1. Setting the serial interface

You can select the mode of the serial interface with keys  and  in the input field "**Ser.mode**", confirming your selection with the  key afterwards. There are five different types of operation available: 1. = "Cam-BUS", 2. = "Standard", 3. = "Multiuser", 4. = "S5-L1" and 5. = "3964R". When you select a specific communication mode, you have to make sure that every connected device you want to make contact with supports this communication mode. Please note also, that you can specify the type of serial interface with your order of the CamCon. You can choose between an RS232 or an RS485 interface. All four "Ser.Modes" operate with the RS232 point to point communication as well as with the RS485 BUS communication. See also chapter "4.1.8.2. Pin allocation of the serial RS485 interface" on page 19 and chapter "7.5.3.1.6. Input of the unit number" on page 72.

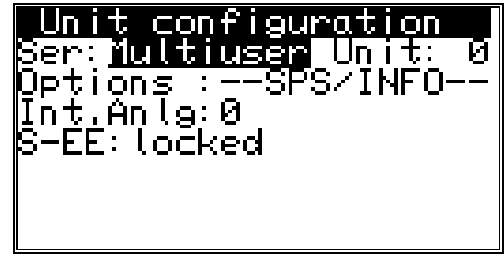

```
Unit configuration
Ser: Multiuser Unit: 0
Options : --SPS/INFO--
Int. Anlg: 0
S-EE: locked
```

Note: As a standard, the device comes with Ser.Mode set to "**Multiuser**" and the unit number set to "**0**".

7.5.3.1.1. The "Cam-BUS" communication mode

Select this mode, if you want to be able to program or display CamCon cam controllers from different places, e.g. you want the CamCon, the daughter display CD10 and the PC via the RS485 BUS.

Attention: Using the configuration above or similar requires that all CamCon devices, as well as any connected PC be equipped with an RS485 serial interface and a software of at least December 1996.

7.5.3.1.2. The "Standard" communication mode

The standard mode operates with point to point communication, i.e. you can only connect 2 devices, e.g. a CamCon to a PC or a CamCon to a CamCon DC50/51 Terminal. Since this communication mode does not use any protocol security, its usage is only allowed for testing purposes.

7.5.3.1.3. The "Multiuser" communication mode

Contrary to the "**Cam-BUS**" mode, it is "**not**" possible to operate several devices, e.g. CamCon Terminal DC51/T4, the daughter display CD10 and the PC, on the RS485 BUS. (**PRESET**)

7.5.3.1.4. The "S5 - L1" communication mode

This setting is necessary, if you want to program the CamCon device via a Siemens S5 CPU. The process is a point to point communication, i.e. you can only connect the CamCon and the Siemens S5 CPU. If you want to store the data of your CamCon on a PC, you have to break your connection to the S5 CPU. For the S5 - L1 communication mode, you can order a connection set composed of: a TTY cable, function segments and a handbook (Ordering.No.: PCXX/S5-L1 XX=CamCon Type).

7.5.3.1.5. The "3964(R)" communication mode

This setting is necessary, if you want to program the CamCon device via a serial interface with the RK512 procedure. The process is a point to point communication.

7.5.3.1.6. Input of the unit number

In the Multiuser and in the Cam-BUS operation, you need to set a unit number for every device on the BUS. This number can be set under the menu point "UnitNo:" and is then displayed in the main menu in the highest line on the display. You may only allocate each unit number once for a single linked RS485 BUS operation. Because of this, you need to set the "UnitNo" and the "Multiuser" or "Cam-BUS" mode for every device separately, before connecting the serial interfaces.

7.5.3.1.7. Programming via remote

If you want to program the CamCon from a separat control, you can order a handbook with a description of the programming sequences (Ordering.no.: H-DC50/PROTO).

7.5.3.2. Additional device options

At the time, the CamCon has the options "PLC", "SPS/INFO/HSR" and "PLC/INFO" available. If want your CamCon to be equipped with one of these options, please specify with your order : ("PLC" = S) ("PLC/INFO" = M) ("SPS/INFO/HSR" = C).

These options are described in an extra handbook (H-PLC), which is not in the supply package of the CamCon.

7.5.3.2.1. PLC Logic Module

The firm Digitronic Automationsanlagen GmbH is an accomplished and well-known supplier and developer of electronic cam controllers for the industry. The experiences of connecting PLC controls and cam controllers, collected in years of close cooperation with the users, have been regarded during the creation of the PLC Logic Module. The result is a PLC software for the CamCon, that works parallel to the cam controller. The in- and outputs of the cam controller are linked without external logics or hardware, e.g. Timers (Way - Time - Cams), Set - Reset - Functions, and registers and can so be operated within the cycle time of the cam controller. This combination guarantees the best possibility of using the advantages of the CamCon speed compensation and the logic of the PLC, without the loss of switching speed because of slow external switching elements (e.g. relays, timers and central PLC controls with high cycle time).

7.5.3.2.1.1. Examples for using the PLC logic module

Example 1: Output deactivation.



Output 1 of the CamCon is cleared if inputs 1 and 8 are active.

Example 2: Output depending on the rotation direction.

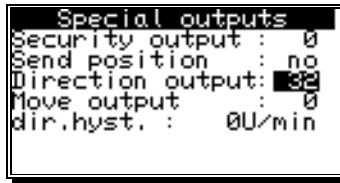

Output 1 of the CamCon is enabled when the rotation direction output 32 is **active**.

This is the case when the direction of the rotation is **positive**.

Output 1 of the CamCon is enabled when the rotation direction output 32 is **not active**.

This is the case when the direction of the rotation is **negative**.

Example 3: Flank assessment.

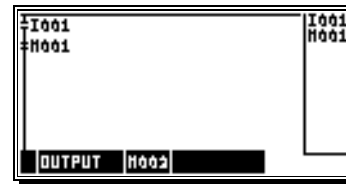

Register 2 is activated for one cycle when the signal at input 1 changes from 0 to 1.



Register 2 is activated for one cycle when the signal at input 2 changes from 1 to 0.

7.5.3.2.2. PLC Logic Module with text display

Available with the PLC Logic Module is a text display you can use to show and describe the different states of your machine.

Example:

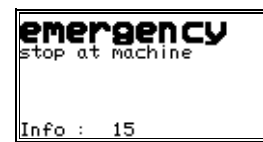
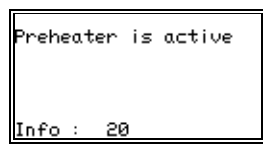
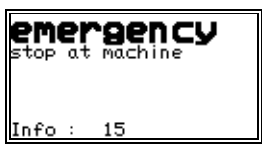

7.5.3.3. Analog outputs

The electronic cam controllers of the CamCon series are equipped with analog outputs (CamCon DC40/50/51 optionally, CamCon DC115 as a standard), via which speed, position or the cam values can be emitted as analog signals.

Note: With units CamCon DC16, DC90 and DC300 you can only use the analog outputs by connecting a CamCon DAC16 digital - analog - converter to the external interface.

7.5.3.3.1. Clearing the integrated analog outputs

At the time, units CamCon DC40/50/51 (optionally) and CamCon DC115 (as a standard) are supplied with integrated analog outputs. The outputs are cleared by setting their number in the menu point "Int.Anlg". The possible numbers are 0,1 and 2. A value of 0 deactivates the integrated outputs.

Note: Not possible with CamCon DC16 and DC90.

If the value is greater than 0, a line for adjustments appears below the menu point "Int.Anlg".

```
Unit configuration
Ser:Multiuser Unit: 0
Options :--SPS/INFO--
Int.Anlg: 0
S-EE: unlocked
```

7.5.3.3.2. Adjusting the integrated analog outputs

Note: With units of increment DC51/S5., DC51/J5. or DC40/S5. this feature is neither necessary nor possible.







The integrated analog outputs of the CamCon have to be regulated from time to time and after the first activation. Offset and amplification can be adjusted. The maximum analog output voltage is $\pm 10V$ with a resolution of 8Bit. Should you wish for a smaller voltage range, you can edit the maximum voltage via the amplification factor.

Offset output 1

```
Unit configuration
Ser.mode:Multiuser
Unitno. : 1
Options :--SPS/INFO--
Int.Anlg: 2
Analog 1=> 0.000V ←→
```

Amplification factor output 1

```
Unit configuration
Ser.mode:Multiuser
Unitno. : 1
Options :--SPS/INFO--
Int.Anlg: 2
Analog 1=> 10.000V ←→
```

With keys  and  you can set the amplification and the offset through repeated adjustments with the keys and measuring the analog output voltage. From analog output 1 to analog output 2 and to switch between offset and amplification factor, press keys ,  or . When all 4 adjustments are made, the input is ended with the  key and the menu is left.

See also chapters "7.4.5.3.1. The analog speed output" on page 63, chapter "7.3.18. Programming analog cams" on page 44 and chapter "7.4.5.3.2. Configuration of the analog cams" on page 63.

7.5.3.3.3. External analog outputs

Additional external analog outputs can be connected to a CamCon through a CamCon DAC16 digital - analog - converter module at the external interface.

7.5.3.4. Locking EEPROM memory

If an PLC-controll writes or programs parameter, Cams or Delay-Times cyclical (eg. DC300 or CP16) the unit's EEPROM-Memory will be destroyed after a short time. If cyclical programming is, for a certain reason, necessary, you therefore have to lock the EEPROM.

```
Unit configuration
Ser: Multiuser Unit: 0
Options : --SPS/INFO--
Int. Anlg: 0
S-EE: Locked
```





Therefore select **S-EE** in menu "unit configuration" and change it by pressing  to "locked". If the EEPROM is locked, **all** data will only be written to RAM and will be deleted if the voltage is switched off.

Attention: After having finished a complete deleting, this value is set to "unlocked" again.

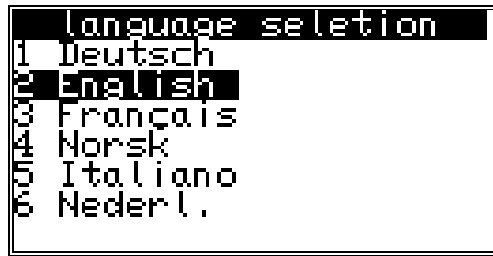
7.5.4. Language

If you selected the menu point "Language" in the "Configuration" menu, the menu for the language setting appears:



Here you can move the dark field to the desired language using the keys , ,  and . You adapt the selected language by pressing the  key.

7.5.5. Configure user

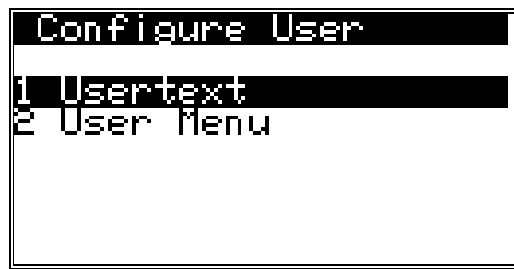

If you choose the menu-point "Configure User" in the menu "Unit Configuration", the following menu appears on your display.

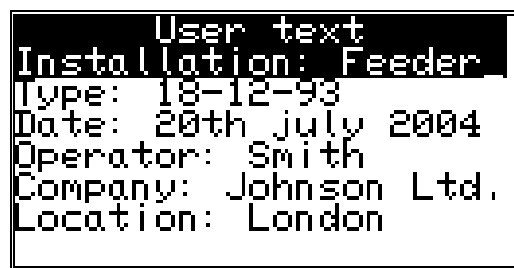

7.5.5.1. User text

If you selected the menu point "User text" in the "Configuration menu", the following menu appears on the display. Here you can enter general information about e.g. your machine for the CamCon to display. There are 7 lines available, with 21 characters each.



For the input of the text please see the chapter "5.8. Text input" on page 28. You can store the text and move on to the next page by pressing the  key. You can exit this menu at any time with the  key.

7.5.5.2. User-Menu/OP-functions

If you choose the menu-point **"Configure User"** in the menu **"User menu"**, the following menu appears on your display.

Here you are able to feed in own input - or display functions into the CamCons Standart - Display. This helps the final customer to change or controll Cams, delay - times (speed compensation) and Variables of the PLC - Logic - Module without having access to the units submenus.

For informations about the definition of this feature please read chapter "User's menu/ OP-Functions" in the PLC - Logic - Module's manual (Order nmb.: H-SPS).



7.5.6. Configure Hardware

7.5.6.1. Simple Hardware Configure

Fill in the physical inputs and outputs here. Using e.g. a CamCon DC90 this would be 16 inputs and 24 outputs, using a DC16 8 inputs and 16 Outputs, using a CamCon DC300 8 inputs and 24 outputs or using a CamCon 1756-DICAN 0 inputs and 24 outputs.

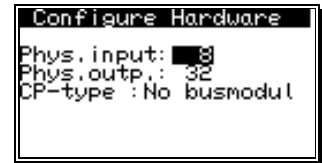

7.5.6.2. Enhanced Hardware Configure (I/O - Routing)

To enter the Enhanced Hardware Configure, press the **[INS]** key and the following **"Modul"** definition menu appears:

Here you can select with the keys **[←]** and **[→]** your CamCon basic hardware (e.g. DC51/.....).



After you press **[CR]** you can now enter the device depending hardware selection. If the CamCon basic hardware already defined you can enter the device depending hardware selection by press **[#]**.

Select now with the keys **[←]**, **[→]** and **[CR]** your CamCon hardware in reference to the CamCon order number (Ausbaust.). For example **"DC51/...24G..."** if you have a CamCon DC51 with 16 digital inputs, 32 digital outputs, 1 analog input and 1 analog output.

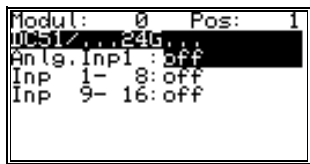
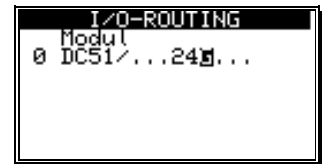

If you press **[CR]** at the last position the menu appears to assignment (routing) the hardware to the software.

First you select with the keys **[←]**, **[→]** and **[CR]** the inputs and then you assign secondly by pressing the **[#]** key the outputs. With the keys **[↓]** and **[↑]** you can jump between the menupoints.

You can quit the menus by press the keys **[#]** or **[ESC]** (Note: **[ESC]** dit'n save the last value).

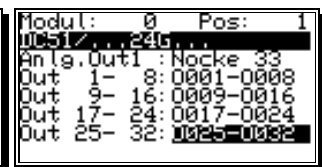
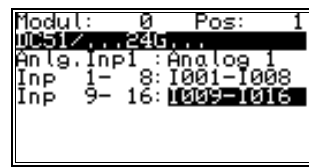

Then you are back in the **"Modul"** definition.



Here you can now insert a additional hardware module who are connected to the **"External Interface"** of the CamCon by press the key **[INS]** or scrolling down with the key **[↓]**.

Note: "Nocke 33" mean here "1. Analog Cam" after digital output 32.

Select like before the Hardware (order number) and assignment the hardware to the software (start enter input with **[#]**).

Note: A hardware modul can **easily** remove by pressing the **[DEL]** key. If all modules are erased, the **"Simple Hardware Configure"** is active again.

7.5.6.3. CP16 Module

```
Configure Hardware
Phys.input:  8
Phys.outp.: 32
CP-type : Profibus
```

If a CP16 Profibus (CP16/P) or Interbus (CP16/I) Module gets connected to your CamCon, you can switch the CP-type by pressing to "Profibus" respective "Interbus"-press key .

Using a Profibus-DP-Module you can now enter your favoured Profibus-DP-adresse and confirm by pressing .

Additional to the CamCon's physical In - or Outputs the CP16 - module is able to simulate In - or Outputs, that can be evaluated or controlled by an PLC

```
Configure Hardware
Phys.input:  8
Phys.outp.: 32
CP-type : Profibus
slave address: 0
CP input  :  0
CP output  :  0
```

Attention: Simulated Inputs, controlled by PLC must not be directly frequented in Cam-switch or PLC-Logic-module, forbeeing not defined for an accurate establishing of communication between CamCon CP16 and CamCon Cam-switch. The Inputs therefore have to be connected with special-input 5 of the PLC-Logic-module AND, which will be set to 1 if sucessfully establishing communication to CP 16.

Note: For more information about the features of an CP16 Module please read the CP16 manual.

8. Device info

If you want to get an overview of whole configuration of the CamCon, you should select the information menu of the unit configuration. Select the main menu point "**Unit configuration**", and press the **ESC** key during the input of the user code (the input of the user key is not required here) or you press the **#** key in the "**configuration menu**". The first page of the information menu appears on the display. With the help of the arrow keys or the **CR** key you can view the other pages. You can exit this menu at all times by pressing the **ESC** key.

```
User text
Installation: Feeder
Type: 18-12-93
Date: 20th July 2004
Operator: Smith
Company: Johnson Ltd.
Location: London
```

- User text inputs

```
Info: Memory
EPROM: 23.03.2009
Cam : 3602/ 192
Delay time : 7406.8 ms
Resolution : 54903
RAM size : 1048576
Ser. EEPROM: 49152
Ser. FRAM : 0
```

- Software version
- Number of free cams / number of programmed cams
- Maximum delay time setting
- Maximum setting for the physical resolution of the measuring system
- Size of the RAM in bytes
- Size of the EEPROM/FRAM storage in byte

```
Info: Measuring sys.
Measur.sys. : TIMER
Hy./Vmax: 0/ 0
Gear : 1/ 1
Format : #####°
```

- Configured measuring system
- Actual position hysteresis (Hy.)
- Encoder controlling (Vmax)
- Rotation direction and gear factor
- Display format of the actual position
- Display of actual Value

```
Info: measuring sys.
SSI Singleturn
360 Gray
Measur.sys. : SSI
Res./offset : 9/ 9
gray offset : 76
SSI-errorbit: 14
```

- detailed configuration of the measuring system

```
Info: measuring offset
System : linear
Start : 1°
Offset : 2°
End : 360°
Preset : 3°
P-inp/typ: 5/EEPROM
```

- Configured moving system
- Activation point of the linear moved system
- Offset (shifting of the zero point)
- Value of the actual position preset
- Input number of the actual position preset / Memory of the actual position preset

```
Info: speed
Factor: 0,16666
Format: ###U/min
100% : 1000U/min
Exact : 1,00%
Display: position / 0
```

- Factor of the speed display
- Display format of the speed display
- 100% value for the speed display
- Accuracy of the speed display
- Display menu of the display type / Input for the display change.

```
INFO: Cable l./cycle
Cable lenght: 30m
target time : 0,000ms
Cycle time : 0,152ms
Temperature : 35°C
```

- Cable length of the measuring system and the external upgrade
- Set planned value of the cycle time
- Cycle time need by CamCon
- Temperature in the encasement of CamCon

```
Info: Special outputs1
Security output : 1
Send position : Gray
Direction output: 2
Move output : 31
Dir.hyst. : 5U/min
Move hyst. : 0%
```

- Output number of the security output
- Format of the displayed actual value
- Output number of the F / R output
- Output number of the stand still output
- Hysteresis for the recognition of the stand still speed

```
Info: Special outputs2
Speed analog : Yes
Analog cam : 2
```

- Analog speed output "yes/no"
- Number of analog cam outputs

```
System upgr.
Inp.: 16 Outp: 32
DTC : 32 NLT: 0( 0)
K-lock-inp.: 0 EQ 0
Enable-input : 0
Prg.-select-Input: 1
NoP.: 2Typ: on pos.
change at : 1%
```

- Number of inputs and outputs
- Number of outputs w. speed compensation
- Input number for keyboard locking
- Input number of error acknowledgement
- Input number for output enable
- Number of externally selectable programs
- Input number of the first input for the external program selection
- Change mode of the program selection

```
INFO: Hardware
Phys.Eing.: 8
Phys.Ausg.: 24
CP-Type : Profibus
Slave Adresse: 4
CP Eing. : 8
CP Ausg. : 8
```

- Configuration of physical hardware in- and outputs
- Configuration towards the CP-16-module (Profibus, Interbus, Can-Bus).

```
Info: PLC
PLC-module: on
MRegisters: 000
XRegisters: 0000
Timer/Cnt.: 0000 ( 0)
Virt. inp.: 0000
Spec. inp.: 0000
Shift: 0* 1( 0)
```

- PLC logic module configuration
- PLC-Logic-module ON/OFF
- Number of M-Registers
- Number of X-Registers
- Number of counters and times
- Number of virtual inputs
- Number of special inputs.
- Number of shift registers with speed compensation

```
Info: Options
Ser: Multiuser Unit: 0
Options : --SPS/INFO--
Int. Analg: 0
S-EE: unlocked
BCLK: 45Mhz BL: 5
EE-WR_CNT: 9257
```

- Mode of the serial interface
- Unit number
- additional options of the e.g. PLC option or PLC option with text display
- Number of internal analog outputs
- CPU - Speed (clock) 16 or 25 Mhz
- Hardware PLC - acceleration (on/off)

```
Info: Analog outputs
Nr. : 1
Format : ###.##%
Minimum : -100.00%
Maximum : 100.00%
Dis. Input : 0
Dis. Wert : -100.00%
Interpol. : Yes
```

- Configuration of the analog cam 1,2, up to 13.
- Input and display format
- Minimal input value (- 10V)
- Maximum input value (+ 10V)
- Input number for switch to dis.value
- Output value if switch off
- Interpolation yes/no

For each of the analog cam the CamCon displays one more information menu. A maximum of 13 analog cam are possible.

```
Info: User in. P: 0.0
Headline :
1. Line
2. Headline :
last line:
```

- Adjustements for OP-functions.

For each line of a menu-page information-menus are shown.

8.1. Stack Info

If a non-defined error happens while the CamCon is in operation, the user is able to controll the stack-variables' allocation which helps the software developers detection of effects. Use to stack-information-menu for this purpose.

```
Info: Stack
Taskname : main
Stacksize : 00001800
Stacktop : 9011103E
Used Stack : 000003D6
Free Stack : 0000142A
Used Stack : 15%
```

Please note the information shown on screen. At the moment, we are able to show a maximum of 6 stack-information menus. Please note their content and send it by fax to. +49/6126/945342.

Note: Using a CamCon DC16; 40; 50/51 and DC90 only 4 stack-menus are shown. these are called **iotask**, **rs232task**, **dc40task** and **main** A CamCon DC 115 also shows tasks called **DC115_0**, **DC115_1**; a CamCon DC300 also shows **DC300**.

9. Error messages and removal of errors (FAQ)

The error messages appear on the standard display or in CamCon DC16, 90, 115, 300 and 1756-DICAM without a display of their own through the status LED or status bits. The drawing below shows the error message appearing for 'Position - Error 3'.



The display for other errors is almost the same.

9.1 Problem: Display shows "No contact to unit: XX".

Possible causes:

The wiring is probably not correct, no device with the selected unit number is on the BUS or the setting of the 'Ser.Mode' is wrong.

Solution:

Check the wiring and the configuration of the serial interface.

See chapter "4.1.8.2. Pin allocation of the serial RS485 interface" on page 19 and chapter "7.5.3. Unit configuration" on page 71.

9.2. Problem: "Pos - Err:1" respectively error number 1.

Possible causes:

The measuring system has not been correctly connected.

Solution:

Please check the wiring to the measuring system. Please consult the instruction manual to the measuring system.

If the error is eliminated, the error-message can be deleted by pressing

9.3. Problem: "Pos - Err:2" respectively error number 2.

Possible causes:

The measuring system is faulty or not connected.

The setting of the error bits in the special measuring system setting is not correct.

Solution:

Check the wiring to the measuring system.

Check the inputs of the measuring system resolution.

Consult the instruction manual of your measuring system.

If the error is eliminated, the error-message can be deleted by pressing

9.4. Problem: "Pos - Err:3" respectively error number 3.

Possible causes:

The resolution of the connected measuring system is not in accord with the input resolution. The measuring system is faulty. The actual value is outside the range which was entered in the menu path setting for linear systems. See Chapter "7.4.2.2. Measuring offset with a linear moved system" on page 56. If an incremental measuring system is set, then this report is an alternative for the message "Clear...".

Solution:

Check the input of the measuring system setting, the offset value and the cable length setting. Consult the instruction manual of your measuring system. Consult Chapter "**Problem: Clear...**".

If the error is eliminated, the error-message can be deleted by pressing

9.5. Problem: "Pos - Err:5" respectively error number 5.

Possible causes:

The measuring system control is activated. The CamCon has registered a large unacceptable actual value jump. The measuring system is possibly faulty.

Solution:

Check the input of the measuring system setting and of the setting of the cable length or increase the permitted actual value jump. Consult Chapter "7.4.1.3. Controlling the measuring system" on page 47. Consult the instruction manual of your measuring system.

If the error is eliminated, the error-message can be deleted by pressing

9.6. Problem: An "Pos-Error:" occurs during operation.

The monitor displays "Pos-Err:1", "Pos-Err:2", "Pos-Err:3" or "Pos-Err:5".

Possible causes:

The connection cable of the measuring system or the measuring system itself is defective. A cable without screening or without dual strand was used. The laying of a connection cable in the vicinity of a strong electromagnetic source of interference (e.g. high voltage cable, motor cable) can lead to an pos error.

Solution:

Check the wiring to the measuring system. Replace the measuring system. Take measures for screening. Lay the connection lead in another location. Consult the instruction manual of your measuring system.

If the error is eliminated, the error-message can be deleted by pressing

9.7. Problem: "RAM-Full" = RAM memory is full.

Possible causes:

The resolution of the measuring system is too large.
The number of outputs is too high.
The number of Speed Compensated outputs is too high.

Solution:

Check the input of the measuring system setting.
Reduce the measuring system resolution.
Reduce the number of Speed Compensated outputs.

Please contact your customer service representative if you require a RAM memory extension.

9.8. Problem: The EEPROM memory is full.

Cause:

Too little memory space available in the EEPROM for the storage process.

Solution:

Please contact your customer service representative if you require an EEPROM storage extension. Also consult Chapter "11. Calculation EEPROM cam storage on page 87.

9.9. Problem: Outputs will not activate

Possible causes:

An error message is active. The outputs are not connected to power supply. A programmed Cam is too short or gets too short by increasing rotation speed. The enable - Input is not set.

Solution:

Check the error message. Program a longer Cam. A Cam with delay-time/speed-compensation must at least have the length of two steps.

Enable Outputs at the enable-Input, see also chapter 7.4.6.7. Input for enabling Outputs on page 65. Enable the outputs through the S5 PLC. Consult your handbook for the S5-L1 linkage.

9.10. Problem: "Out - Error" respectively error number 4.

Possible causes:

Your outputs are overloaded or short-circuited. Check the wiring and the connection output as well as possible inductive loads which have no zero setting or are driven by a cancellation component.

The number of set inputs is not correct.

Power failure at an external interface module (e.g. DC91/IO or DC16/IO).

Solution:

See chapter "4.3. The outputs" on page 25.

See chapter "7.4.6. System upgrading" on page 65.

See chapter "7.5.6. Configure Hardware" on page 77.

If the error is eliminated, the error-message can be deleted by pressing 
Here the attempt to reset outputs is done

Warning:

Wires crossing behind the outputs, if the cables leading towards the switch-OFF of the outputs are in an awkward position, can lead to a switch-OFF of the outputs, since in an open situation a potential is built up which, when the contacts are closed, is led back into the outputs.



In inductive loads the outputs must be organised with a flywheeling diode. Protection or induction in the switch cabinet in the immediate vicinity of the device or due to their wiring have an effect on the device or its wiring and must be organised with cancellation components.

9.11. Problem: Error in the EEPROM respectively error number 255.



Possible causes:

The data of the EEPROM was changed or destroyed by interference.

One of the existing data carriers (EEPROM or EPROM) was renewed or is defective.

The power supply was switched OFF during alteration of the data.

Solution:

Press  for yes and then the  key. All data will be erased and must be re-entered. Should these errors occur repeatedly, please contact your customer service.

9.12. Problem: "Error ???"

Possible causes:

An unpredictable error has occurred.

Solution:

Please contact your customer service.

9.13. Problem: "Clear...."

Cause:

The CamCon is waiting for the arrival of the Clear signal in an incremental measuring system.

Solution:

Set the Clear signal ON or activate an actual value Preset. The result is the immediate release of the Cam Switch Unit.

Note: The incremental measuring system is only available as an option for CamCon DC16, DC50/51, DC115, DC300 and CamCon 1756-DICAM.

See chapter "7.4.1.6.3. Incremental - measuring system" on page 50.

10. Menu outline

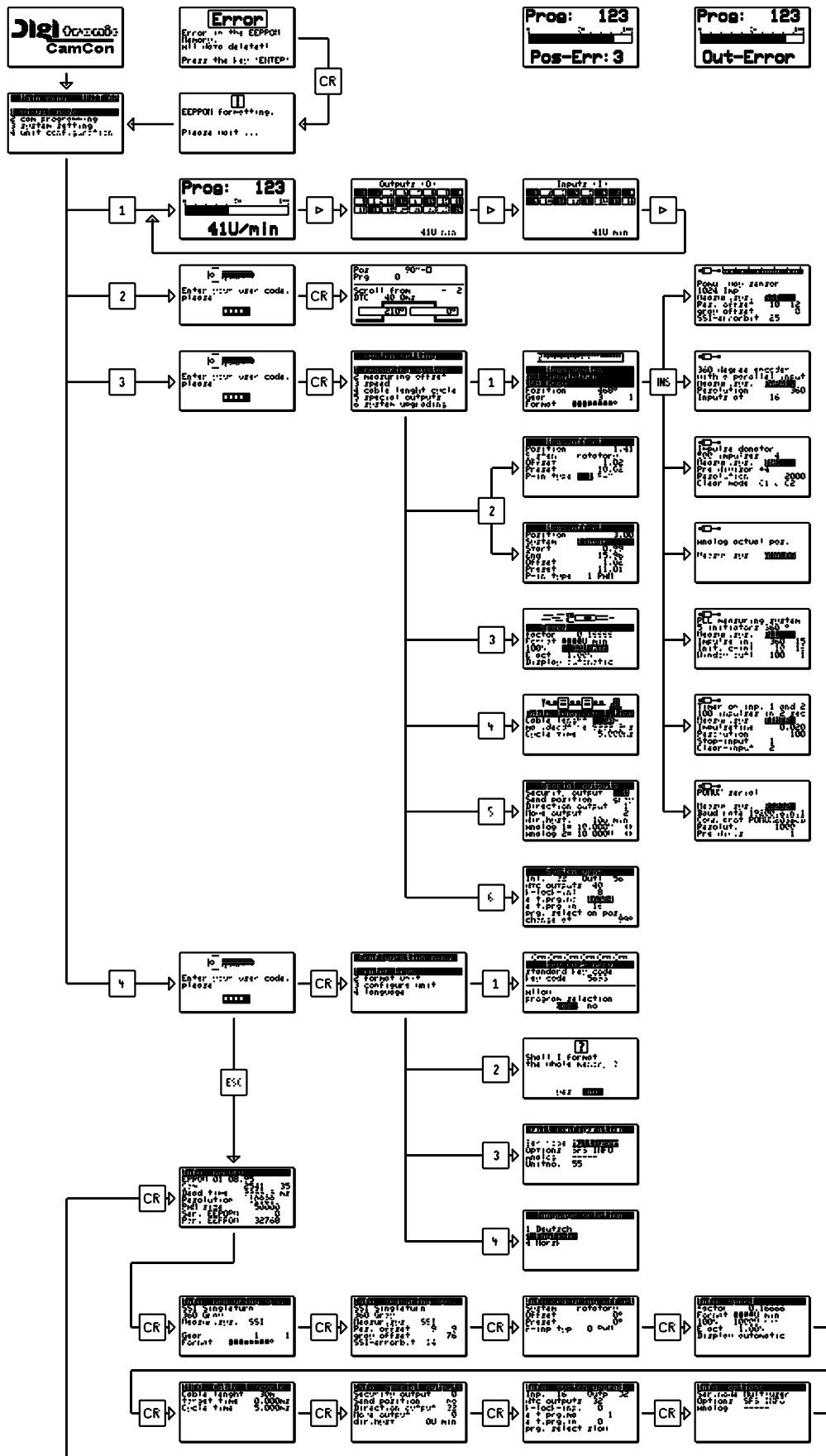

11. Calculation EEPROM cam storage

In the CamCon you have the opportunity to extend the **EEPROM** Cam storage. The storage space required for programming is influenced by the following factors:

- | | |
|--|-------------|
| 1. Basic requirement | = 256 Bytes |
| 2. Per cam | = 12 Bytes |
| 3. Per set delay time for Speed Compensation | = 12 Bytes |
| 4. Per name for an output | = 24 Bytes |
| 5. Per set key / code | = 66 Bytes |
| 6. For a special measuring system | = 66 Bytes |
| 7. For direct or "actual" program selection | = 12 Bytes |
| 8. Per set program name | = 48 Bytes |
| 9. Per line of the OP function | = 72 Bytes |

The value is generated by the CamCon with the following formula:

Storage requirements in Bytes	=	Basic needs
	+	Number of cams * 12
	+	Number of delay times for Speed Compensation * 12
	+	Number of output names * 24
	+	Number of user keys * 66
	+	66 when the special measuring system is available.
	+	12 when "on Pos" program selection is set.
	+	48 * number of set program names.
	+	72 * number of set lines of the OP function.

Example 1: The Cam Switch Unit is supposed to have 8 Programs each with 16 cams and Speed Compensation for 16 outputs.

$$\text{Storage requirement in Bytes} = 256 \text{ Bytes} + (8 \text{ Programs} * 16 * 12 \text{ Bytes}) + (16 * 12 \text{ Bytes})$$

$$\text{Storage requirement} = 1984 \text{ Bytes}$$

Example 2: The Cam Switch Unit is supposed to have 20 programs each with 16 cams and 16 delay times for Speed Compensation.

Storage requirement in Bytes	=	256 Bytes
	+	(20 Programs * 16 * 12 Bytes)
	+	(16 TZK * 12 Bytes)
	+	(16 Output names * 24 Bytes)
	+	(1 User keys * 66 Bytes)

$$\text{Storage requirement} = 4738 \text{ Bytes}$$

Warning: Through alterations in the storage structure of the CamCon software, the extent to which storage capacity is used up can differ from software version to software version!

12. Calculation the RAM storage-requirement for CamCon

The required **RAM**-main storage (not similar to the constant value - Camstorage or the EEPROM) depends on 7 factors:

- | | |
|---|---|
| 1. Standard consumption | (approximately 100000 Byte) |
| 2. Number of outputs | (8 to 200 in steps of 8 outputs). |
| 3. Cycle time | (displayed in milliseconds). |
| 4. Actual value/measuring system resolution | (displayed in impulses) |
| 5. Maximal Speed-compensation | (0 to 9999.9 in steps of 100 microseconds). |
| 6. Mode of program selection | (the double amount of storage is required).
(See also chapter "7.4.6.9. Setting the program selection mode" on page 66). |
| 7. Size of the EE-Prom storage | (EE-Prom - storage size in Byte for Cache). |

The RAM - storage requirement is calculated by the following formula:

$$\text{storage requirement in Bytes} = \text{standard consumption} + \frac{\text{Number of outputs} * \text{Actual value resolution} * (2 \text{ If program Mode not slow})}{8} + \frac{\text{max. delay-time} * 4}{\text{cycletime}} + \text{EE-Prom size}$$

Example 1: The camswitch with a resolution of 360°, an EE-Promstorage of 32kByte, 16 outputs, a speed-compensation of 1000ms and a cycletime of 250µs needs:

$$\text{Storage requirement in Bytes} = 100000 + \frac{16 * 360}{8} + \frac{1000 * 4}{0.250} + 32768$$

$$\text{Storage requirement in Bytes} = 100000 + 720 + 16000 + 32768$$

$$\text{Storage requirement in Bytes} = 149488 = \text{ca. } 150\text{kByte}$$

Example 2: The camswitch with a resolution of 8192°, an EE-Promstorage of 48kByte, 64 outputs, a speed-compensation of 500ms and a cycletime of 250µs, needs:

$$\text{Storage requirement in Bytes} = 100000 + \frac{64 * 8182}{8} + \frac{500 * 4}{0.250} + 49152$$

$$\text{Storage requirement in Bytes} = 100000 + 65536 + 8000 + 49152$$

$$\text{Storage requirement in Bytes} = 222688 = \text{ca. } 220\text{kByte}$$

Note: If the required RAM - storage requirement greater than the CamCons total amount of storage, you need to reduce the measuring system's resolution.

Attention: Changings in the storage-structure of the CamCon software the storage requirement can alternate at different software-versions!

13. Technical data of the CamCon

Display	graphical display with 128x64 pixels for user prompting and programming (optional with background illumination)
Number of outputs	8, 16, 24, 32 expandable up to 200 through the expansion bus
Number of inputs.....	8, 16 expandable up to 200 through the expansion bus.
Analog output	2 optional analog outputs for the speed display or for the programming through analog cams
Number of programmable cams	150, optionally 600, 2500, 3700 or 10500 cams
Data security/storage	EEPROM
Number of programs.....	32768
Cycle time (switching speed)	from 0,1ms, is adjusted to the needs (optimized)
Dead time compensation (DTC)	individually adjustable for every output according to the measuring system and the memory
Adjustment range of the DTC	0 to max. 9999.9ms according to the measuring system and memory
Exactness of the DTC	+0 to -1 step
Measuring system input	synchronous serial (SSI), gray coded, optional incremental data input, optional parallel data input, analog data input, PLL data input, time controlled data input
Resolution of the measuring system....	360 steps (standard), otherwise adjustable according to measuring system and memory
Measuring system SSI	AAG60007 (360 degree SSI standard type) AAG612-2048, AAG612-4096, AAG612-8192, AAG626 oder AAG66107.
Border frequency of the incremental input.....	about 200kHz
Input level of the incremental input.....	5V RS244 or 24V PNP.
Zero point correction of the measur. sys.	is programmed by the CamCon
Rotation direction of the measuring sys.....	is programmed by the CamCon
Length of the connection cable between the measuring system and the CamCon.....	with SSI to max. 300m (optionally up to 1000m)
Supply voltage.....	24V DC \pm 20 %
Measuring system supply voltage	with 24V DC through the supply voltage of the CamCon
Current reception	300mA without measuring system and outputs
Output voltage.....	24V DC, plus switching
Output current	500mA per output, short circuit proof permanent current (see chapter 4.3. The outputs on page 25).
Connections for:	
Measuring system	through plug block pins
Voltage supply.....	through plug block pins
Cam outputs.....	through plug block pins
Operating temperature.....	0°C to +55°C
Cover type for:	
Front plate / full sight gate.....	IP 67 / IP 55
Cabinet.....	IP 54
Dimensions	see fig. page 14
Front plate part.....	138 ⁺¹ x 138 ⁺¹ mm
Cabinet:	
Switch plate cabinet by DIN 43700	144 x 144 x 63mm (wxhxd)
Cover of the front plate	optional full sight gate, can be locked
Weight.....	about 1000g

14. Key word table

3964(R)	71
Actual position preset.....	57
Actual position, Output.....	61
Adding cams	37
Adding cams, Example	42
AG615 - Single - Multiturn - Measuring system	53
Analog cam, Adding.....	45
Analog cam, Changing.....	45
Analog cam, Configuration.....	63
Analog cam, First creation	45
Analog cams, Programming	44
Analog measuring system input.....	23
Analog outputs	74
Analog outputs, adjusting.....	74
Analog outputs, Clearing integrated.....	74
Analog outputs, External	74
Analog, Position output	65
Analog, Speed output.....	63
brake functions.....	12
Cable covers	14
Cable length	60
Cam deletion.....	38
Cam input.....	36
Cam programming	33
Cam search.....	37
Cam track, Deletion	38
Cam-BUS.....	71
CE	2
centre pressure	12
Clear.....	85
Commissioning	29
Communication mode.....	71
Complete deletion	70
Configure Hardware	77
configure user.	76
Connections	15
Contrast setting.....	26
Controll.....	47
Controlling the measuring system.....	47
Copying cam tracks	39
Copying programmed outputs.....	39
Copying programs.....	40
CP Inputs/Outputs.....	78
CP16 Module	78
Cycle time	60
Delay time compensation, Effects.....	9
delay time for Speed Compensation, separate for switch-ON and switch-OFF points.....	13
Delay time, Calculation	11
Deleting programs.....	40
Deletion of a particular cam, Example	43
Device info	79
Dimensions	14
Direction output.....	62
Dis.input. with analog cams	64

Dis.value with analog cams.....	64
Display format, Actual position.....	48
Display, Change.....	31
Display, LCD.....	26
Display, Standard.....	31
Display, Type.....	59
DP adresse.....	78
EEPROM cam storage, Calculation.....	87
EEProm storage is full.....	84
EEPROM, Error.....	84
Enable, outputs.....	65
Encoder-controll.....	47
Error - aknowledging, input.....	65
Error messages.....	82
Examples for cam programming.....	41
External interface.....	20
External program selection, Setting.....	66
Gear, Electronic.....	48
Grounding pins.....	14
HIPER - measuring system.....	54
Hiperface.....	23
Hysteresis.....	62
Hysteresis, Actual position.....	46
incremental.....	54
Incremental - measuring system, Configuration.....	50
Incremental measuring system input.....	22
Input of text.....	28
Input wiring.....	25
Inputs, In general.....	25
Inputs, Setting.....	65
Inputs, Status display.....	31
Installation.....	14
Installation procedures.....	14
Interbus.....	78
Interpol. with analog cams.....	64
Key functions, Outline.....	27
Keyboard.....	26
Keyboard lock, Setting.....	65
Keys, Checking.....	69
Language.....	76
Linear system, Measuring offset.....	56
Locking EEPROM memory.....	75
MachineCams.....	67
Machineprogram.....	67
Main menu.....	31
MasterCams.....	67
Masterprogram.....	67
Measuring offset.....	56
Measuring system.....	46
Measuring system, General information.....	21
Measuring system, Selection.....	46
Menu outline.....	86
Menu point, Selection.....	27

Menu, Selection	27
millenium	2
Move hysteresis	62
Move output	62
Movement direction, Change	48
Multiturn measuring system with electronic gear	51
Multiuser.....	71
NLT	13; 35; 65
No contact to unit XX	82
Offset	56
OP - Function.....	77
Options, Additional	72
Out - Error	84
Output name, Programming	36
Output selection for programming	33
Output, Deletion	38
Outputs with DTC, Setting.....	65
Outputs, 40mA	25
Outputs, 500mA	25
Outputs, additional	78
Outputs, In general.....	25
Outputs, lock	65
Outputs, Setting	65
Outputs, Status display	31
Parallel - Gray special measuring system.....	50
Parallel measuring system input	21
PDF - File.....	2
Pin allocation.....	15
Pin allocation, Analog input.....	15
Pin allocation, Analog outputs.....	15
Pin allocation, Incremental measuring system.....	16
Pin allocation, Inputs	16
Pin allocation, Outputs	17
Pin allocation, Serial interface.....	18
Pin allocation, SSI measuring system.....	16
Pin allocation, Voltage supply	17
PLC Logic Module.....	72
PLC Logic Module with text display.....	73
PLC Logic Module, Examples.....	72
PLL measuring system	52
PLL measuring system input.....	24
Pos - Err 1	82
Pos - Err 2.....	82
Pos - Err 3.....	83
Pos - Err 5.....	83
Preset.....	57
Profibus	78
Program change	32
Program name	32
Program number	32
Program selection for programming	34
Program selection mode	66
Programing way-Cams	35
Programming	33
Programming the delay time/speed compensation , Private.....	34
Programming via remote.....	72

RAM, storage requirement, calculation.....	88
RAM-Full	83
RK512 Prozedur.....	71
Roll - Over.....	54
Rotation direction, Change.....	48
RS232 as a measuring system	24
RS232 measuring system	53
S5 - L1.....	71
Security output	61
Ser.mode	71
Serial interface	18
Serial interface RS232	18
Serial interface RS485	19
Serial interface, Configuration	71
Shifting cam tracks.....	39
SIM - measuring system simulator.....	54
Special measuring system	49
Special measuring system, Deletion.....	55
Special outputs.....	61
special outputs, analog	63
special outputs, digital.....	61
Speed adjustment.....	58
speed compensation for on-/off-switchpoint	34
Speed Compensation, Effects	9
Speed Compensation, not linear.....	13
Speed compensation, not linear	35; 65
Speed display, Accuracy.....	59
Speed display, Display format.....	58
Speed display, Range adjustment	58
Speed factor.....	58
SSI - measuring system	49
SSI measuring system input	21
Stack Info	81
Standard.....	71
Standstill output.....	62
System upgrading	65
Table of contents	3
Teach - In.....	37
Technical data.....	89
Text input	28
Time -Cam	13
Time emitter measuring system simulation	52
Timer as a measuring system.....	24
Unit configuration	46; 68; 71
Unit number, Input	72
UP - Date	2
User key, Creation	68
User key, Deletion.....	69
User keys, Allocation.....	68
user menu	77
User terminal, Outline	26
User text.....	76
Vmax.....	47
Welding operations, Safety precautions	25

Y2K	2
Zero offset.....	56
Zero offset, External.....	57